



EV36S with Hot Top and French Plates Shown

## EV Series Electric Ranges

### MODELS

EV12

EV24S

EV36S

EV48S

EV48SS

EV60SS

EV72SS

### - NOTICE -

**This Manual is prepared for the use of trained Hobart Service Technicians and should not be used by those not properly qualified.**

**This manual is not intended to be all encompassing. If you have not attended a Hobart Service School for this product, you should read, in its entirety, the repair procedure you wish to perform to determine if you have the necessary tools, instruments and skills required to perform the procedure. Procedures for which you do not have the necessary tools, instruments and skills should be performed by a trained Hobart Service Technician.**

**The reproduction, transfer, sale or other use of this manual, without the express written consent of Hobart, is prohibited.**

**This manual has been provided to you by ITW Food Equipment Group LLC ("ITW FEG") without charge and remains the property of ITW FEG, and by accepting this manual you agree that you will return it to ITW FEG promptly upon its request for such return at any time in the future.**

# TABLE OF CONTENTS

SERVICE UPDATES .....	4
SERVICE UPDATES .....	4
TIS DOCUMENT LIST - EV SERIES ELECTRIC RANGES .....	4
GENERAL .....	5
INTRODUCTION .....	5
INSTALLATION, OPERATION AND MAINTENANCE .....	5
MODEL CONFIGURATIONS .....	5
SPECIFICATIONS .....	5
TOOLS .....	6
SERVICE PROCEDURES AND ADJUSTMENTS .....	8
OVEN THERMOSTAT CALIBRATION .....	8
GRIDDLE THERMOSTAT CALIBRATION .....	8
HOT TOP THERMOSTAT CALIBRATION .....	9
INFINITE SWITCH TEST (208V/240V) .....	10
3 HEAT SWITCH TEST (480V) .....	10
HEATING ELEMENT TEST .....	11
REMOVAL AND REPLACEMENT OF PARTS .....	13
FRONT CONTROL PANEL .....	13
OVEN CONTROL PANEL .....	13
KICK PANEL .....	14
RANGE TOPS .....	14
OVEN DOOR .....	15
OVEN HEATING ELEMENTS .....	16
TOP ELEMENT .....	16
BOTTOM ELEMENT .....	16
FRENCH PLATE .....	17
HOT TOP .....	18
GRIDDLE HEATING ELEMENT .....	18
OVEN THERMOSTAT .....	19
GRIDDLE AND HOT TOP THERMOSTATS .....	20
3 HEAT SWITCH / INFINITE SWITCH .....	21
INDICATOR LIGHTS .....	22
ELECTRICAL OPERATION .....	23
COMPONENT FUNCTION .....	23
COMPONENT LOCATION .....	23
STANDARD OVEN SEQUENCE OF OPERATION .....	24
208/240V .....	24
480V .....	24
WIRING DIAGRAMS .....	25
EV12 RANGE TOP - 208V & 240V .....	25
EV12 RANGE TOP - 480V .....	26
EV24 RANGE TOPS - 208V & 240V .....	27
EV24 STANDARD OVEN - 208V & 240V .....	28
EV36 & EV60 RANGE TOPS - 208V & 240V .....	29
EV36 & EV60 STANDARD OVEN - 208V & 240V .....	30
EV24 RANGE TOPS - 480V .....	31
EV24 STANDARD OVEN - 480V .....	32
EV36 RANGE TOPS - 480V .....	33
EV36 STANDARD OVEN - 480V .....	34
TROUBLESHOOTING .....	35
TROUBLESHOOTING - STANDARD OVEN .....	35

TROUBLESHOOTING - RANGE TOPS ..... 35

# SERVICE UPDATES

## SERVICE UPDATES

November 2022

- Updated OVEN THERMOSTAT CALIBRATION.
- November, 2018**
- Added TIS Document List.

## TIS DOCUMENT LIST - EV SERIES ELECTRIC RANGES

### SERVICE TAB

Document Title	Document Type
EV Series Electric Restaurant Ranges Service Manual	Service Manual

### SERVICE TAB (Multimedia)

Document Title	Document Type
Repair Flood-Damaged Equipment	Misc
EV Series Electric Restaurant Ranges	Operator
EV Series Ranges W/Griddle Elements	Technical Service Bulletin (TSB)
EV Series with French Plates Replacement 18 Ga. French Plate Wiring	Technical Service Bulletin (TSB)
Rating Plate Locations on Current Vulcan-Hart/Wolf Range Equipment	Technical Service Bulletin (TSB)
SB 1023 EV Series Ranges with French Plates	Technical Service Bulletin (TSB)
TSB 1037A Hobart to Vulcan "Common" Model Cross Reference List	Technical Service Bulletin (TSB)

### PARTS TAB

Document Title	Document Type
EV Series Electric Restaurant Ranges Parts Catalog	Parts Catalog

# GENERAL

## INTRODUCTION

This manual is for the Vulcan EV Series Electric Restaurant Ranges. Procedures in this manual will apply to all models unless specified. Pictures and illustrations will be of model EV36S with one French Plate and one 24" Griddle section unless otherwise noted.

All of the information, illustrations and specifications contained in this manual are based on the latest product information available at the time of printing.

## INSTALLATION, OPERATION AND MAINTENANCE

For detailed installation, operation and cleaning instructions, refer to F38251 Installation & Operation manual sent with each unit. The manual is also available online at [www.vulcanequipment.com](http://www.vulcanequipment.com).

## MODEL CONFIGURATIONS

The EV electric ranges come with a standard oven (S) and are available in several different range top configurations such as: French Plates, Griddles or Hot Tops. A second (S) in the model number indicates an additional range with a standard oven in the configuration (double oven).

- EV12 - 12" wide range section that provides additional range top heating selections of 2 French Plates or 1 Hot Top.
- EV24S - 24" wide electric range with available range top selections.
- EV36S - 36" wide electric range with available range top selections.
- EV48SS - 48" wide electric range, two combined 24" ranges with available range top selections.
- EV60SS - 60" wide electric range, two combined 24" and 36" ranges with available range top selections.
- EV72SS - 72" wide electric range, two combined 36" ranges with available range top selections.

## SPECIFICATIONS

AVAILABLE VOLTAGES - 208 OR 240 VOLT - 1 OR 3-PHASE, 480 VOLT - 3-PHASE											
Model Configuration	Nominal AMPS Per Line Wire										
	3-Phase									1-Phase	
	208V			240V			480V				
	X	Y	Z	X	Y	Z	X	Y	Z	208V	240V
<b>12" Range</b>											
EV12-2FP	9.6	17.0	9.6	8.3	14.0	8.3	4.2	7.2	4.2	19.0	17.0
EV12-1HT	---	---	---	---	---	---	---	---	---	24.0	21.0

AVAILABLE VOLTAGES - 208 OR 240 VOLT - 1 OR 3-PHASE, 480 VOLT - 3-PHASE											
Model Configuration	Nominal AMPS Per Line Wire										
	3-Phase									1-Phase	
	208V			240V			480V				
	X	Y	Z	X	Y	Z	X	Y	Z	208V	240V
<b>24" Range, Std Oven</b>											
EV24S-4FP	37.5	37.5	33.3	32.5	32.5	28.9	16.3	16.3	14.4	62.5	54.2
EV24S-2HT	41.6	41.6	41.6	36.1	36.1	36.1	18.1	18.1	18.1	72.1	62.5
<b>36" Range, Std Oven</b>											
EV36S-6FP	37.5	50.0	54.1	32.5	43.3	46.9	16.3	21.7	23.5	81.7	70.8
EV36S-3HT	41.6	62.5	62.5	36.1	54.1	54.1	18.1	27.1	27.1	96.2	83.3
EV36S-2HT2FP	37.5	58.3	62.5	32.5	50.5	54.1	16.3	25.3	27.1	91.4	79.2
EV36S-1HT4FP	37.5	54.1	58.3	32.5	46.9	50.5	16.3	23.5	25.3	86.5	75.0
EV36S-2FP24G	35.0	45.0	51.6	30.3	39.0	44.7	15.2	19.5	22.4	76.0	65.8
EV36S-1HT24G	35.0	49.1	55.8	30.3	42.6	48.4	15.2	21.3	24.2	80.8	70.0
EV36S-4FP12G	35.0	47.5	54.1	30.3	41.1	46.9	15.2	20.6	23.3	78.8	68.3
EV36S-2HT12G	35.0	55.8	62.5	30.3	48.4	54.1	15.2	24.2	27.1	88.5	76.7
EV36S-36G	35.0	42.5	49.1	30.3	36.8	42.6	15.2	18.4	21.3	73.1	63.3

**NOTE:**

1. FP = French Plate (2 per 12" section); HT = Hot Top (1 per 12" section); G = Griddle (12", 24" or 36" wide); and S = Standard oven. Additional information on the wiring configurations, kilowatts and amperage values can be found under WIRING DIAGRAMS.
2. Ranges are factory wired for 3-phase service but are field convertible to 1-phase. Refer to the wiring diagrams in this manual or schematic decals attached to the range for the necessary wiring changes.
3. All ranges over 36" wide will have two separate electrical connections.

## TOOLS

**Standard**

- Standard set of hand tools.
- VOM with minimum of NFPA-70E CATIII 600V, UL/CSA/TUV listed. Sensitivity of at least 20,000 ohms per volt and the ability to measure DC micro amps. Meter leads must also be rated at CAT III 600V.

**Special**

- Temperature tester (thermocouple type) with surface mount probe.
- Clamp on type amp meter with minimum of NFPA-70E CAT III 600V, UL/CSA/TUV listed.
- Two standard 1/4"- 20 x 1" bolts (allen head recommended). The bolts are used to relieve spring tension on the door hinge during door removal and installation.
- Loctite® 246™ for door handle screws.
- A non-permanent type sealer (preferably fast drying) such as nail polish or equivalent for sealing thermostat adjustment screw. If using Loctite® 242™, it begins to set in approximately 10 minutes and fully cures in 24 hours according to manufacturer.

# SERVICE PROCEDURES AND ADJUSTMENTS

## OVEN THERMOSTAT CALIBRATION

1. Place a temperature tester probe in the geometric center of the oven.
2. Set the infinite switch (1, Fig. 1) for the top oven element to OFF during oven thermostat calibration.
3. Set the thermostat (2, Fig. 1) to 350°F.
4. Allow the thermostat to cycle three times.
5. Note the tester reading when the oven indicator light (3, Fig. 1) turns ON and OFF.

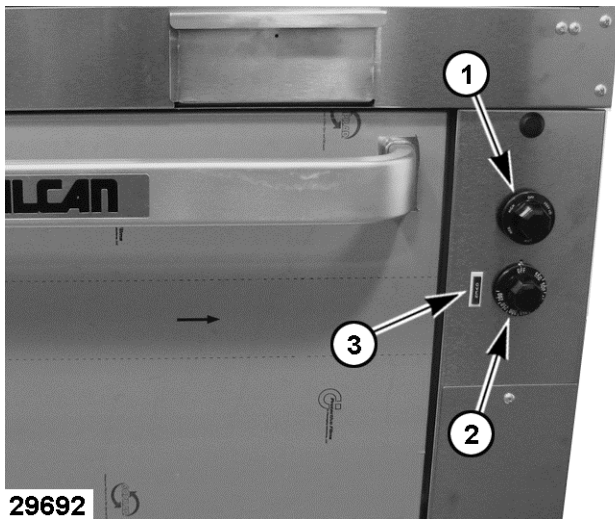

Fig. 1

6. Add these two temperatures together, then divide the sum by 2 to obtain an average temperature.
  - A. If the average temperature is within 25°F of the set temperature, the thermostat is calibrated.
  - B. If the average temperature is not within 25°F of the set temperature:
    - 1) Remove thermostat knob. Maintain thermostat setting during removal.
    - 2) Hold thermostat stem to prevent movement. Insert a flathead screwdriver into thermostat stem (1, Fig. 2) until it reaches the calibration screw.

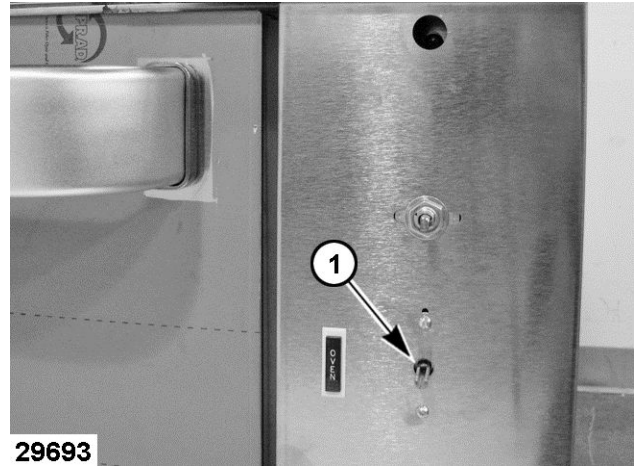

Fig. 2

- 3) Turn adjustment screw counterclockwise to increase and clockwise to decrease temperature.

**NOTE:** A 1/4 turn equals 35°F change.

7. Replace knob and repeat steps 4 to 6 until average temperature is within 25°F of set temperature.
8. Reseal adjustment screw to prevent movement.
9. If thermostat cannot be calibrated, replace thermostat as outlined under OVEN THERMOSTAT.

## GRIDDLE THERMOSTAT CALIBRATION

1. Clean temperature test area on griddle surface then place temperature tester surface mount probe at that location. See table for proper testing locations according to griddle size.

**NOTE:** This procedure will need to be performed for each testing location on the 24" and 36" griddles.

Griddle Size	Distance(s) From Left Edge of Griddle
12"	6"
24"	6", 18"
36"	6", 18", 30"

**NOTE:** All readings taken 12" from front of griddle.

2. Set thermostat to a temperature above 300°F.
3. Allow thermostat to cycle three times.



4. Note tester reading when the indicator light turns ON and OFF.
5. Add these two temperatures together then divide the sum by 2 to obtain an average temperature.
  - A. If the average temperature is within 25°F of the set temperature, the thermostat is calibrated.
  - B. If the average temperature is not within 25°F of the set temperature:
    - 1) Remove thermostat knob. Maintain thermostat setting during removal.
    - 2) Hold thermostat stem to prevent movement. Insert a flathead screwdriver into thermostat stem until it reaches the calibration screw.



Fig. 3

- 3) Turn adjustment screw clockwise to increase and counterclockwise to decrease temperature.

**NOTE:** A 1/4 turn equals 35°F change.

6. Replace knob and repeat steps 3 to 5 until average temperature is within 25°F of set temperature.
7. Reseal adjustment screw to prevent movement.
8. If thermostat cannot be calibrated, replace thermostat as outlined under GRIDDLE AND HOT TOP THERMOSTATS .

## HOT TOP THERMOSTAT CALIBRATION

1. Clean temperature test area surface in the center of the Hot Top then place temperature tester surface mount probe at that location.
2. Set thermostat to 350°F.

**NOTE:** The equivalent on the numbered dial is approximately 5.

3. Allow the thermostat to cycle three times.
4. Note the tester reading when the indicator light turns ON and OFF.
5. Add these two temperatures together, then divide the sum by 2 to obtain an average temperature.
  - A. If the average temperature is within 25°F of the set temperature, the thermostat is calibrated.
  - B. If the average temperature is not within 25°F of the set temperature:
    - 1) Remove thermostat knob. Maintain thermostat setting during removal.
    - 2) Hold thermostat stem to prevent movement. Insert a flathead screwdriver into thermostat dial stem until it reaches the calibration screw.



Fig. 4

- 3) Turn adjustment screw clockwise to increase and counterclockwise to decrease temperature.

**NOTE:** A 1/4 turn equals 35°F change.

6. Replace knob and repeat steps 3 to 5 until average temperature is within 25°F of set temperature.
7. Reseal adjustment screw to prevent movement.
8. If thermostat cannot be calibrated, replace thermostat as outlined under GRIDDLE AND HOT TOP THERMOSTATS.

### INFINITE SWITCH TEST (208V/ 240V)



**⚠ WARNING**

Certain procedures in this section require electrical test or measurements while power is applied to the machine. Exercise extreme caution at all times and follow Arc Flash procedures. If test points are not easily accessible, disconnect power and follow Lockout/Tagout procedures, attach test equipment and reapply power to test.

**NOTE:** Refer to AI4007 in WIRING DIAGRAMS for switch terminal locations.

1. Lower the FRONT CONTROL PANEL to access infinite switch for a French Plate.
  - A. If checking infinite switch for the oven, remove OVEN CONTROL PANEL.
2. Connect a voltmeter to the output terminals H1 and H2.
3. Reconnect power to machine.
4. Turn knob to the desired setting.
5. Compare the percentage of ON time to OFF time.

**NOTE:** ±7.5% tolerance allowable.

Knob Setting	% on Time	Seconds on	Seconds off
Hi	100	ALL	0
Med.	48	15	15
Low	37	8	14

Knob Setting	% on Time	Seconds on	Seconds off
Med. Low	28	7	24
Very Low	7	3	33

6. If the percentage is not correct, replace the switch as outlined under 3 HEAT SWITCH / INFINITE SWITCH.

### 3 HEAT SWITCH TEST (480V)



**⚠ WARNING**

Certain procedures in this section require electrical test or measurements while power is applied to the machine. Exercise extreme caution at all times and follow Arc Flash procedures. If test points are not easily accessible, disconnect power and follow Lockout/Tagout procedures, attach test equipment and reapply power to test.

**NOTE:** Refer to AI4008 in WIRING DIAGRAMS for switch terminal locations.

1. Lower the FRONT CONTROL PANEL to access 3 heat switch for a French Plate.
2. Reconnect power to machine.
3. Check input voltage at L3 and L2 on the switch terminals.
4. Check for the correct output voltage at the output terminals for all knob settings of the switch.

Knob Settings	L3 Input - Output at Terminal(s)	L2 Input - Output at Terminal(s)
High	1 & 3	2
Med	1	2
Low	1	3

5. If the voltages are not correct, replace the switch as outlined under 3 HEAT SWITCH / INFINITE SWITCH.

## HEATING ELEMENT TEST



### ⚠ WARNING

**Certain procedures in this section require electrical test or measurements while power is applied to the machine. Exercise extreme caution at all times and follow Arc Flash procedures. If test points are not easily accessible, disconnect power and follow Lockout/Tagout procedures, attach test equipment and reapply power to test.**

**NOTE:** 208/240V - The standard oven uses an infinite switch to control the top element for browning and a thermostat to control the bottom element for oven heating. The thermostat supplies power to the infinite switch and must be ON for the top element to heat.

**NOTE:** 480V only - The standard oven uses a single thermostat to control the top element for browning and the bottom element for oven heating.

1. Set temperature control to the highest setting for the heating element to test:
  - A. Standard oven - top and bottom elements.
  - B. Hot Top element.
  - C. French Plate element.
  - D. Griddle element.
2. Measure voltage at the heating element terminals and verify it against data plate voltage.
  - A. If voltage is *incorrect*, see [TROUBLESHOOTING](#) to help determine the possible cause. If voltage is *correct*, check current draw (amps) through the heating element lead wires.
 

**NOTE:** Checking current draw is preferred over a resistance check when a clamp on type amp meter is available.
  - B. If current draw is correct then heating element is functioning properly. See [HEATING ELEMENT TABLE](#) for proper values. If current draw is *not* correct, turn temperature control OFF and disconnect the electrical supply to the range. On ranges with two ovens, each section will have its own supply power connection.
  - C. Replace heating element for the range as outlined under the appropriate procedure listed below then proceed to step 3:
    - 1) [OVEN HEATING ELEMENTS](#)
    - 2) [HOT TOP](#)
    - 3) [FRENCH PLATE](#)
    - 4) [GRIDDLE HEATING ELEMENT](#)
  - D. If unable to check current draw, a resistance check *may* indicate a malfunctioning element.
    - 1) Disconnect electrical supply to the range. On ranges with two ovens, each section will have its own supply power connection.
    - 2) Remove lead wires from the heating element and check resistance (ohms). See [HEATING ELEMENT TABLE](#) for proper values.
  - E. If resistance is not correct, replace heating element for the range as outlined under the appropriate procedure listed in step 2C.
3. Check for proper operation.

<b>HEATING ELEMENT TABLE</b>				
<b>Voltage</b>	<b>Element</b>	<b>KW per Element</b>	<b>AMPS per Element Lead</b>	<b>OHMS per Element</b>
208	Standard Oven (Top)	1.25	6.0	34.6
	Standard Oven (Bottom)	3.75	18.0	11.5
	Hot Top	5.00	24.0	8.7
	French Plate	2.00	9.6	21.6
	Griddle	3.40	16.3	12.7
240	Standard Oven (Top)	1.25	5.2	46.1
	Standard Oven (Bottom)	3.75	15.6	15.4
	Hot Top	5.00	20.8	11.5
	French Plate	2.00	8.3	28.8
	Griddle	3.40	14.2	16.9
480	Standard Oven (Top)	1.25	2.6	184.3
	Standard Oven (Bottom)	3.75	7.8	61.4
	Hot Top	5.00	10.4	46.1
	French Plate	2.00	4.2	115.2
	Griddle	3.40	7.1	67.8
<b>NOTE:</b>	1. Values in the table are nominal. Tolerance is +/-10%. 2. Voltage values are @ 60Hz. 3. Resistance values (ohms) are @ 77° F.			

# REMOVAL AND REPLACEMENT OF PARTS

## FRONT CONTROL PANEL



**WARNING**

Disconnect the electrical power to the machine and follow lockout / tagout procedures.

1. Pull out grease tray (1, Fig. 5) on models with griddle.
2. Remove 4 screws (2, Fig. 5) from control panel.

**NOTE:** Control panel is hinged and will rotate down.

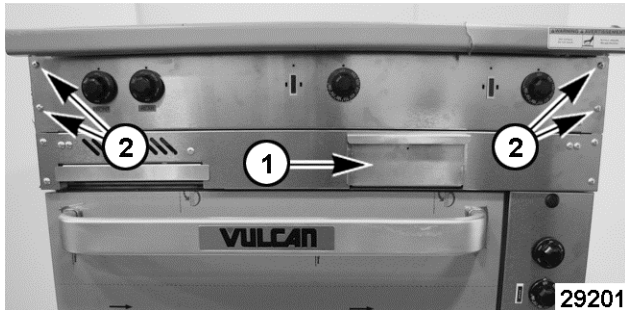

Fig. 5

3. Reverse procedure to install.

## OVEN CONTROL PANEL



**WARNING**

Disconnect the electrical power to the machine and follow lockout / tagout procedures.

1. Remove plug from the access hole in the oven control panel.



Fig. 6

2. Remove screw securing oven control panel to frame.
3. Pull the oven control panel outward at the top and lift to remove from frame.
4. Note wire locations and disconnect from the infinite switch (1, Fig. 7) thermostat (2, Fig. 7) and oven light (3, Fig. 7).

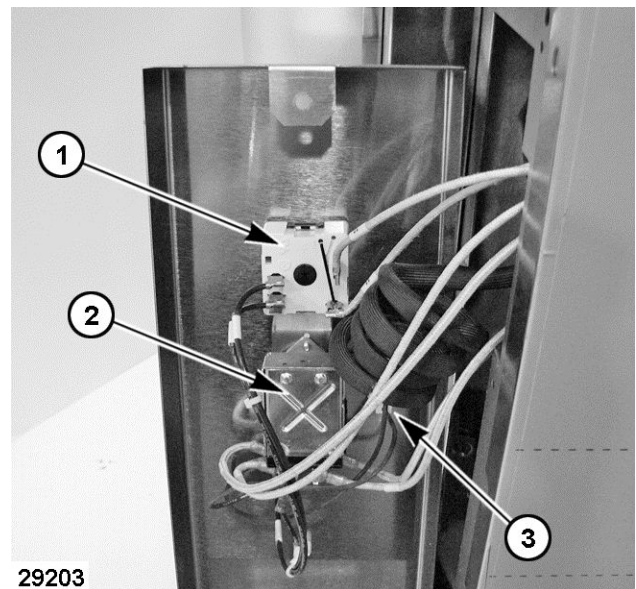

Fig. 7

5. Reverse procedure to install.

## KICK PANEL



### ⚠ WARNING

Disconnect the electrical power to the machine and follow lockout / tagout procedures.

1. Lift kick panel to disengage from the mounting bracket upper pin and allow panel to rotate down.

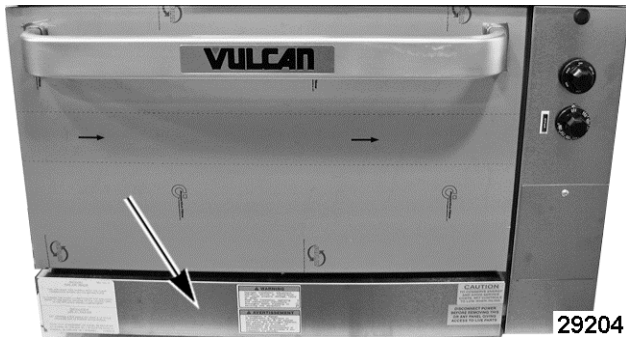

Fig. 8

2. Apply outward pressure on one of the panel mounting ends to disengage from mounting bracket lower pin.
3. Reverse procedure to install.

2. Lift backsplash to disengage the support tabs from mounting slots in frame. Place backsplash to the side until ready to install.
3. Open FRONT CONTROL PANEL.
4. Remove range top as described below:

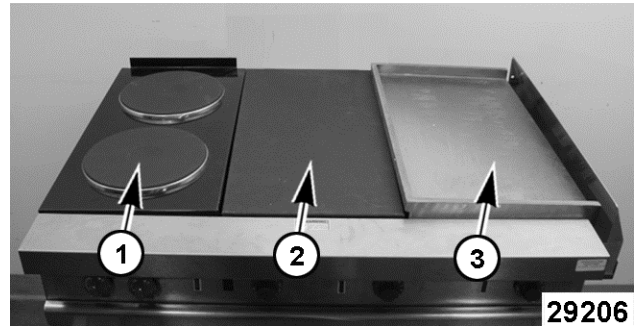

Fig. 10

- A. French Plate (1, Fig. 10) - Remove screws securing French Plate (Fig. 11) to frame.
- B. Hot Top (2, Fig. 10) - Remove screws securing bull nose (1, Fig. 12) to frame then lift bull nose off range.
- C. Griddle (3, Fig. 10) - Remove screws securing bull nose (1, Fig. 12) to frame then lift bull nose off range.

## RANGE TOPS



### ⚠ WARNING

Disconnect the electrical power to the machine and follow lockout / tagout procedures.

1. Remove screws (2, Fig. 9) securing backsplash (1, Fig. 9) to frame.

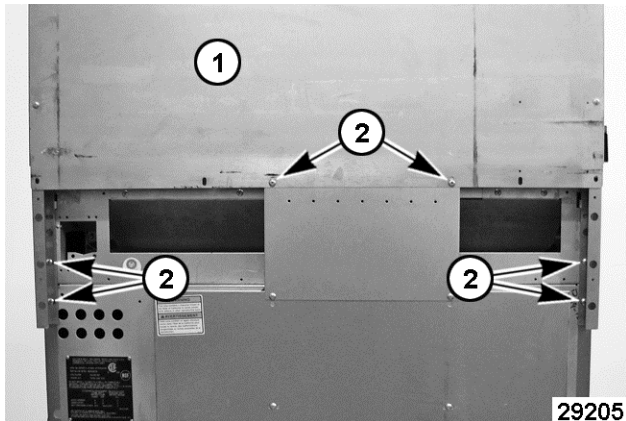

Fig. 9

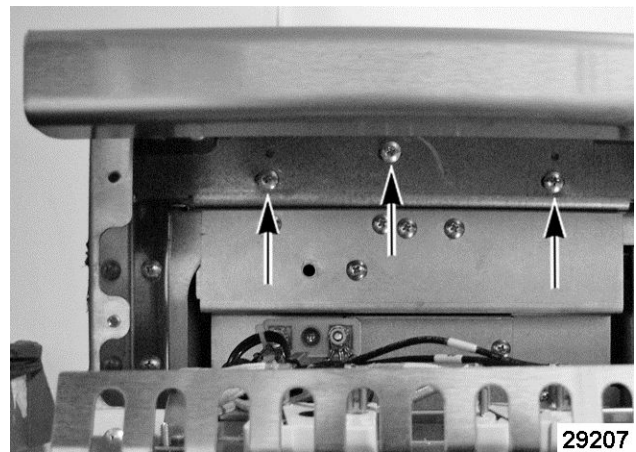

Fig. 11

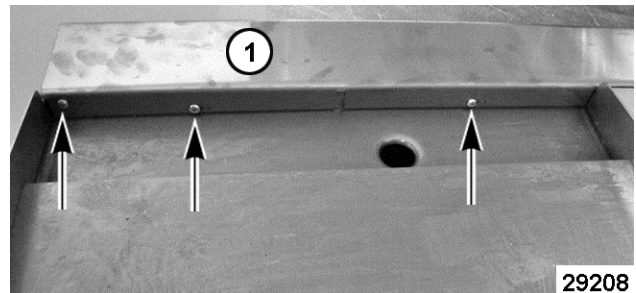

Fig. 12

**NOTE:** On Hot Tops and griddles, the number of screws securing bull nose to frame depends on bull nose length.

5. Lift the range top being removed and position it to access the electrical connections.
6. Disconnect the electrical connections.
7. Reverse procedure to install.
8. Check range top for proper operation.

## OVEN DOOR

### Removal

1. Remove OVEN CONTROL PANEL.

**NOTE:** Removal of the oven control panel is to provide additional space on the right side of door to ease door removal and installation.

2. Lower KICK PANEL.
3. Fully open the oven door.

**NOTE:** Refer to Fig. 13 and the description table below to identify components.

4. Insert a 1/4"-20 x 1" long bolt (as listed under TOOLS) into each door hinge slot at the top of the spring loaded hinge.

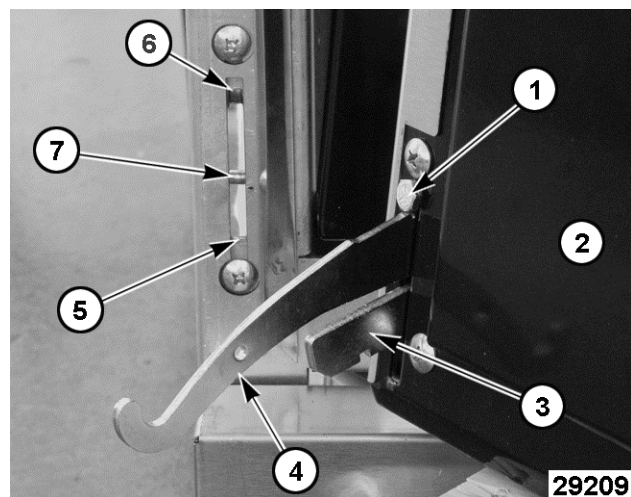

**Fig. 13**

Item	Description
1	Bolt
2	Door
3	Swivel Hinge
4	Spring-Loaded Hinge
5	Bottom Edge of Door Hinge Stop

Item	Description
6	Door Hinge Stop
7	Bar

5. Close door until it's close to the front control panel. As the door approaches this position, you should notice a decrease in the spring tension on the door.
6. Remove door as follows:
  - A. Hold door at bottom corners then lift the door up and out to disengage the swivel hinge and spring-loaded hinge.
  - B. The notch on swivel hinge must release from bottom edge of the door hinge stop to remove door. As needed, lift up on the swivel hinges using forefinger to aid in releasing.
  - C. The spring-loaded hinge must release from the roller inside the slot on door hinge stop to remove door.
7. If replacing door or spring-loaded hinge, position the door face down. Press down on hinge enough to relieve spring force then remove bolt from door hinge slot.

### Installation

1. Compress each spring-loaded hinge enough to insert the bolt into the slot at top of hinge.
2. Hold door at bottom corners while facing the oven cavity. Place knee on the front of door to help balance it as necessary during installation.
  - A. Using index fingers, lift swivel hinges until they touch the spring-loaded hinges and hold in place.
  - B. Tilt the top of door toward the oven so that the swivel hinge is at a slightly downward angle to pass between the bar and bottom edge of door hinge stop.
  - C. Insert door hinges into the slots making sure that the spring-loaded hinges go above the bar to catch on the roller and the swivel hinges go underneath the bar to catch on the bottom edge of door hinge slot.
  - D. Lower the door and position it as necessary to engage the swivel hinge slots with the bottom edge of both door hinge slots. Refer to Fig. 15 below.



Fig. 15

3. Fully open door to check operation. If bottom edge of door rubs the front edge of cavity bottom, then the swivel hinge is not engaged as described.
  - A. To seat the swivel hinge, open door approximately 30° and pull in the same direction on the door handle. The hinge should drop into place.
4. Open door and check operation. If okay, remove bolts and close door. If not okay, remove door and repeat installation procedure.
5. Reinstall oven control panel.
6. Raise kick panel.

## OVEN HEATING ELEMENTS



### ⚠ WARNING

Disconnect the electrical power to the machine and follow lockout / tagout procedures.

#### Top Element

**NOTE:** If the rear of range is accessible, remove rear flue panel to access the top heating element terminals and disconnect lead wires. Otherwise, access is available through the oven cavity as outlined in procedure.

1. Remove oven racks.
2. Loosen element mounting brackets (1, Fig. 16).
3. Remove element mounting screws (2, Fig. 16).

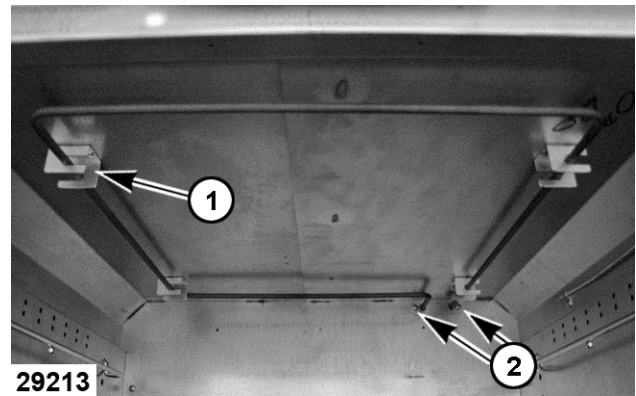

Fig. 16

4. Remove element from brackets.

**NOTE:** Some brackets may need to be removed if turning them will not completely free the element.

5. If removing element through oven cavity, disconnect lead wires from heating element terminals.
6. Remove element from oven cavity.
7. Reverse procedure to install.

**NOTE:** Do not force element into holding brackets.

8. Check range for proper operation.

#### Bottom Element

**NOTE:** The bottom heating element terminals can only be accessed from the rear of the range.

1. Remove the rear flue panel (1, Fig. 17).
2. Remove element cover (2, Fig. 17).

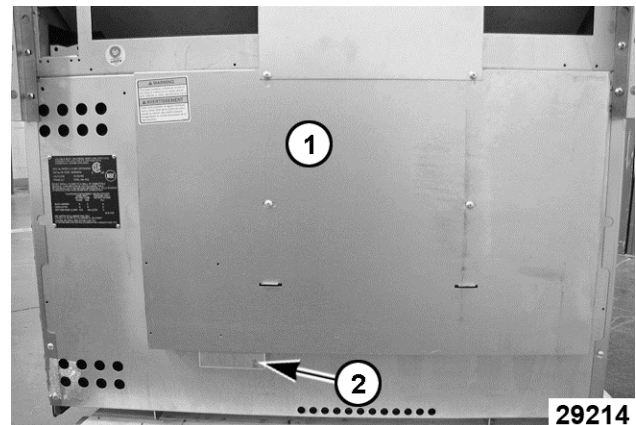

Fig. 17

3. Disconnect lead wires from element terminals (1, Fig. 18).



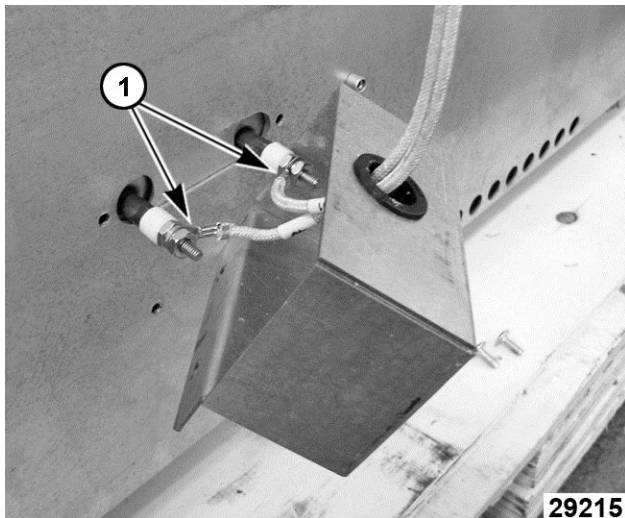

Fig. 18

4. Remove oven racks.
5. Remove oven bottom.
6. Loosen element mounting brackets (1, Fig. 19).
7. Remove element mounting screws (2, Fig. 19).

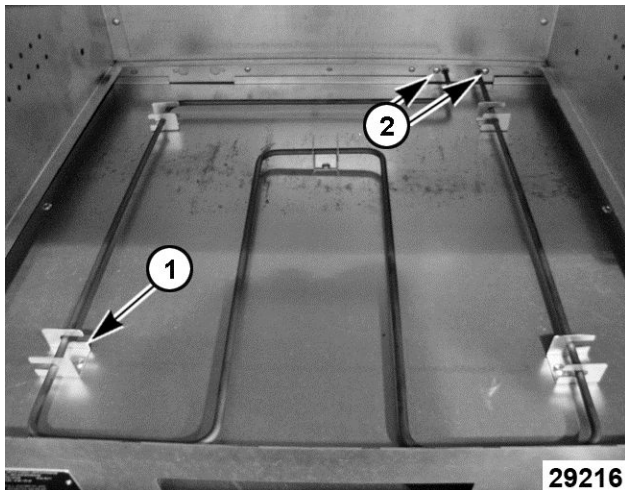

Fig. 19

8. Remove bottom element from mounting brackets and lift out of the oven cavity.
9. Reverse procedure to install.

**NOTE:** Work mounting brackets around until element is secured without force.

10. Check range for proper operation.

## FRENCH PLATE



### ⚠ WARNING

Disconnect the electrical power to the machine and follow lockout / tagout procedures.

1. Remove RANGE TOPS.
2. Remove electrical connections noting their locations (1, Fig. 20).

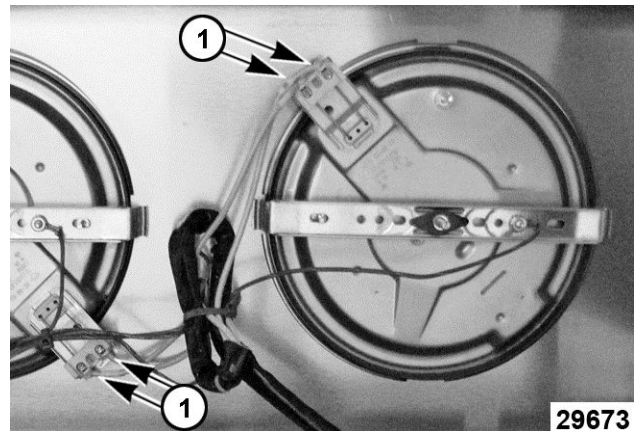

Fig. 20

3. Support the French Plate (1, Fig. 21).
  - A. Remove the nut, spring washer, and locking bracket (2, 3, 4 Fig. 21).

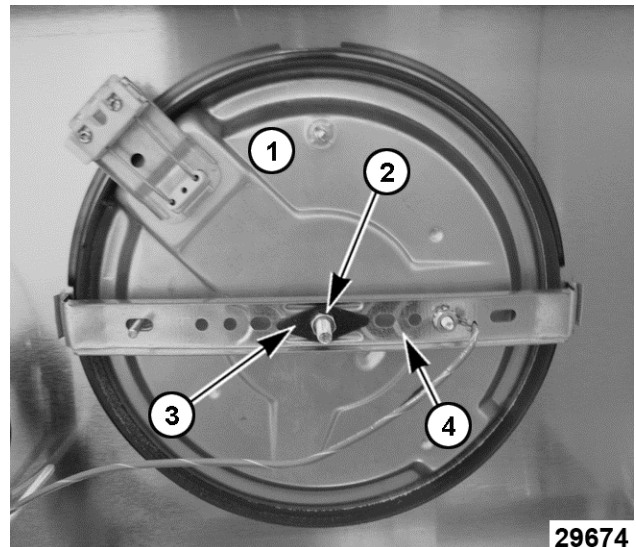

Fig. 21

4. Remove French Plate from range top.
5. Reverse procedure to install.
6. Check range for proper operation.

## HOT TOP



### ⚠ WARNING

Disconnect the electrical power to the machine and follow lockout / tagout procedures.

1. Remove RANGE TOPS.
2. Remove mounting nuts (1, Fig. 22) that hold thermostat bulb clamp (2, Fig. 22) to the plate assembly.

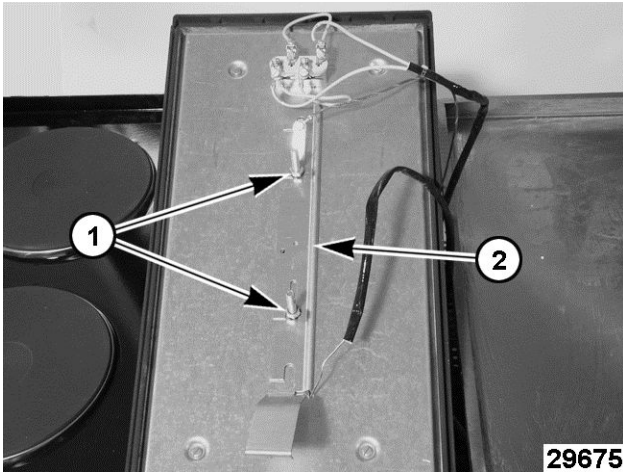

Fig. 22

3. Remove thermostat bulb clamp and thermostat bulb from Hot Top.
4. Remove the inside terminal screws (1, Fig. 23) from electrical connections.

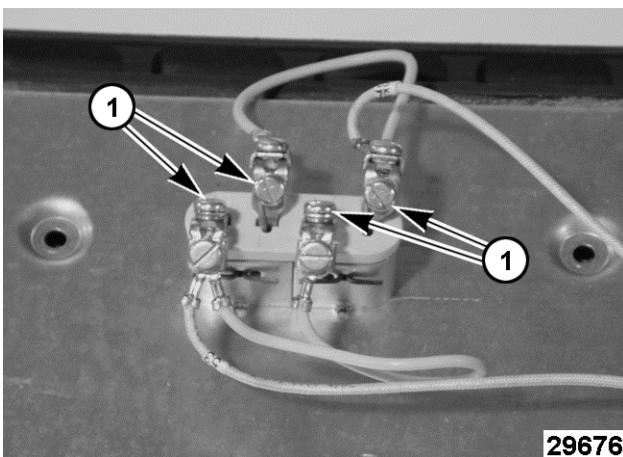

Fig. 23

5. Bend hooks inward slightly (1, Fig. 24) then remove electrical connections.

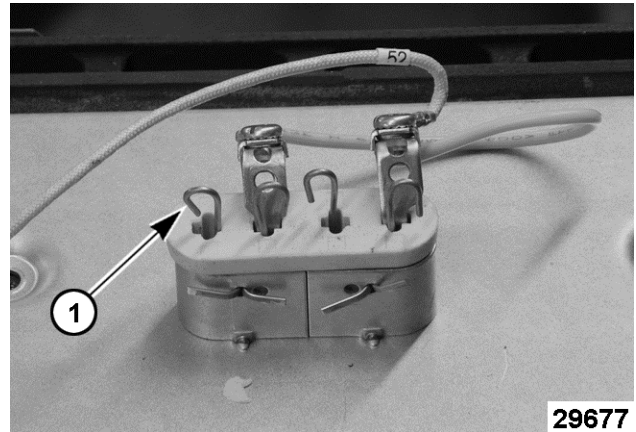

Fig. 24

6. Remove Hot Top.
7. Reverse procedure to install.
8. Check range for proper operation.

## GRIDDLE HEATING ELEMENT



### ⚠ WARNING

Disconnect the electrical power to the machine and follow lockout / tagout procedures.

**NOTE:** 24" wide griddle shown.

1. Remove RANGE TOPS.
2. Remove thermostat bulb from the angle iron weldment (1, Fig. 25) on the bottom of griddle plate.
3. Disconnect element wiring from heating element terminals (2, Fig. 25).

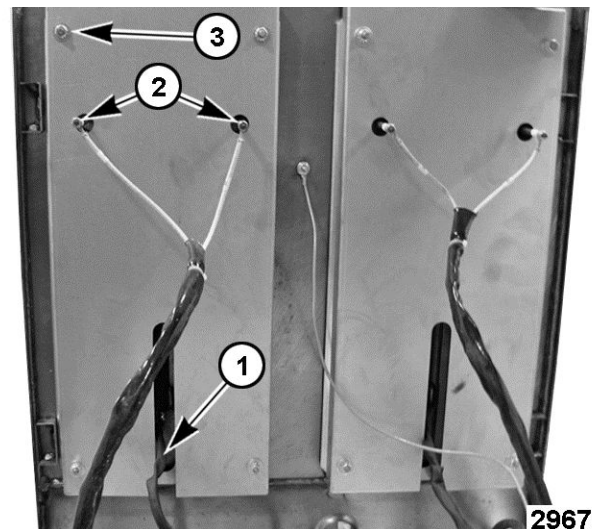

Fig. 25

4. Remove mounting nuts (3, Fig. 25) securing griddle element cover to griddle plate.
5. Remove griddle element cover from griddle plate.
6. Remove mounting nuts (1, Fig. 26) securing the griddle element clamp (2, Fig. 26).

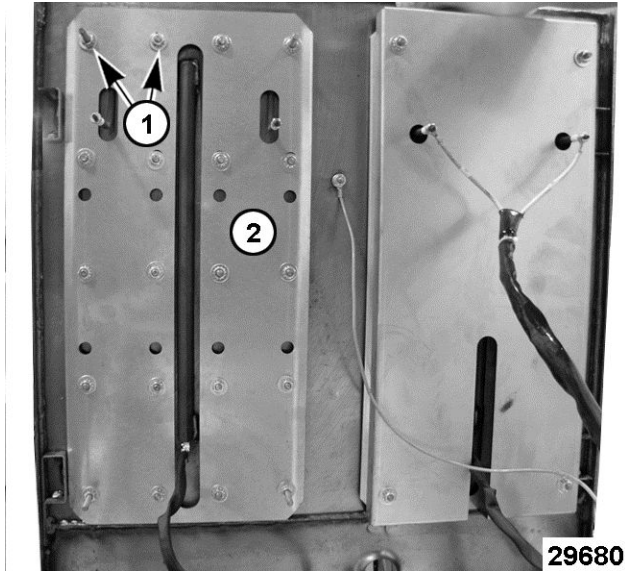

Fig. 26

7. Remove griddle element clamp (2, Fig. 26) from the element and griddle plate.
8. Remove griddle element from griddle plate.
9. Reverse procedure to install.
  - A. Position the element clamp with the downward bend along the sides of the clamp toward the griddle plate.
  - B. Torque the griddle element clamp mounting nuts to 30 to 35 inch-pounds.

**NOTE:** A torque wrench is the preferred method for tightening the griddle element clamp mounting nuts. However, if a torque wrench is not available, tighten all griddle element clamp mounting nuts finger tight, then 1/2 additional turn with a wrench.

10. Check range for proper operation.

## OVEN THERMOSTAT



### ⚠ WARNING

Disconnect the electrical power to the machine and follow lockout / tagout procedures.

1. Remove thermostat knob.

2. Remove thermostat mounting screws.



Fig. 27

3. Remove OVEN CONTROL PANEL.
4. Disconnect lead wires from thermostat noting their locations.

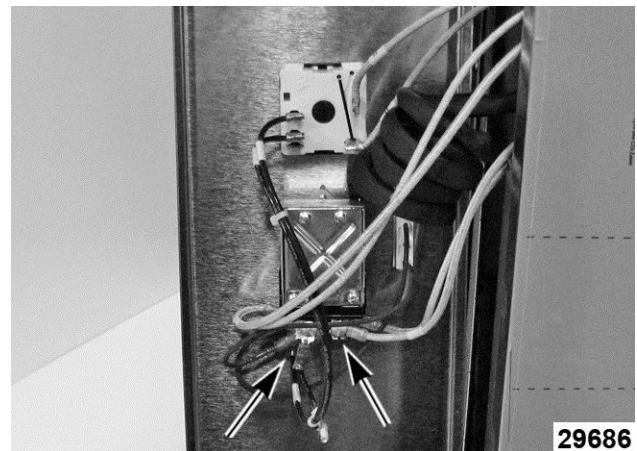

Fig. 28

5. Remove thermostat bulb from the oven cavity mounting clips.
  - A. Pull capillary tube and thermostat bulb through the opening in sidewall of the oven cavity.

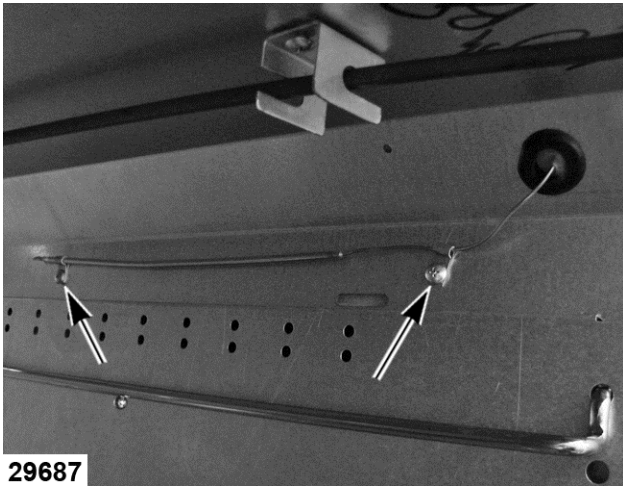

Fig. 29

6. Remove thermostat from oven.
7. Reverse procedure to install.

**NOTICE**

When installing, do not bend and kink capillary tube or damage to the control may occur.

8. Perform OVEN THERMOSTAT CALIBRATION.
9. Check range for proper operation.

**GRIDDLE AND HOT TOP THERMOSTATS**



**WARNING**

Disconnect the electrical power to the machine and follow lockout / tagout procedures.

1. Remove thermostat knob.
2. Remove thermostat mounting screws.

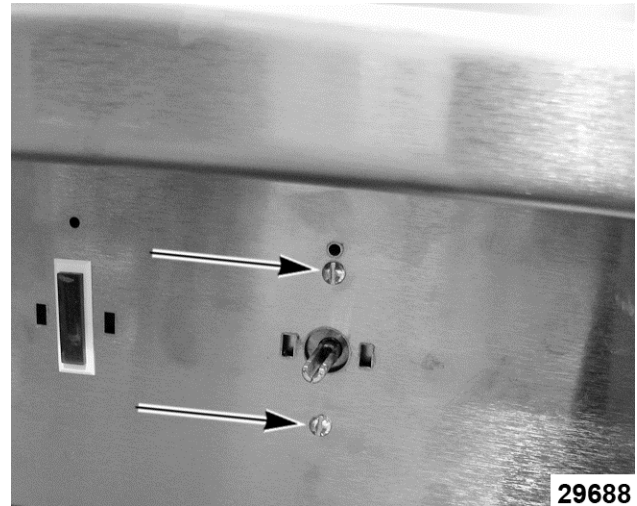

Fig. 30

3. Open FRONT CONTROL PANEL.
4. Disconnect lead wires from thermostat noting their locations.

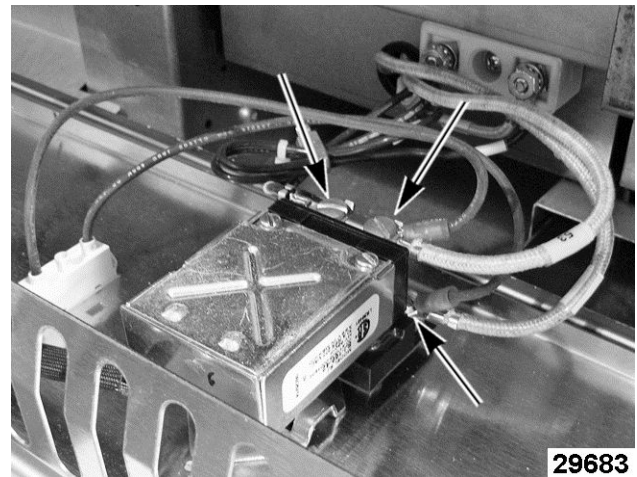

Fig. 31

5. Access the underside of RANGE TOPS. The picture below shows the thermostat bulb and clamp for a Hot Top.
  - A. To access the thermostat bulb and clamp for a griddle, refer to GRIDDLE HEATING ELEMENT.
6. Remove mounting nuts (1, Fig. 32) from thermostat bulb clamp (2, Fig. 32).

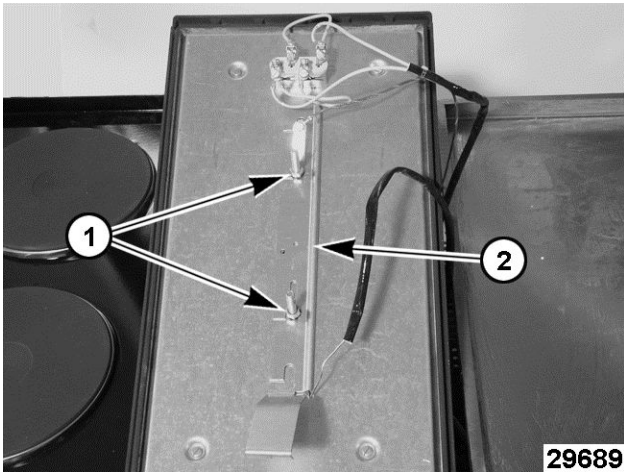

Fig. 32

7. Remove thermostat bulb from clamp.
8. Remove wire tie securing the insulating sheath and capillary tube to frame.
  - A. Remove insulating sheath from capillary tube. Retain for use on replacement thermostat capillary tube.
  - B. Remove thermostat.
9. Reverse procedure to install.

**NOTICE**

When installing, do not bend and kink capillary tube or damage to the control may occur.

**NOTE:** Install the insulating sheath around replacement thermostat capillary tube. Route capillary tube so it does not contact any electrical components and secure to frame using wire ties.

10. Perform HOT TOP THERMOSTAT CALIBRATION or GRIDDLE THERMOSTAT CALIBRATION.
11. Check range for proper operation.

**3 HEAT SWITCH / INFINITE SWITCH**



**WARNING**

Disconnect the electrical power to the machine and follow lockout / tagout procedures.

1. Pull off switch knob.
2. Remove washer nut from switch being replaced.

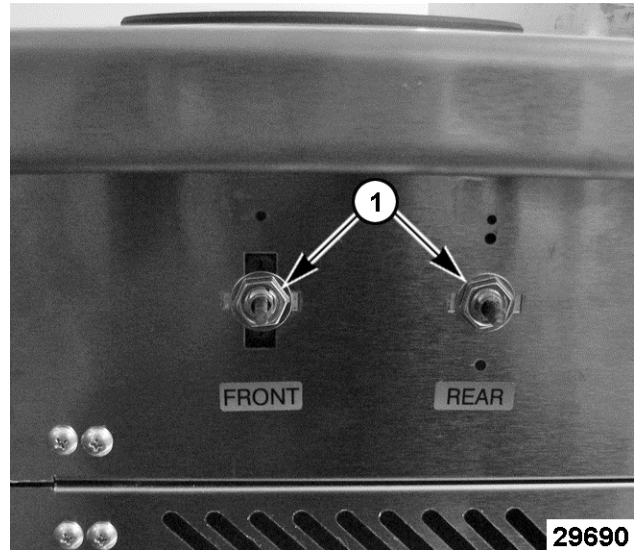

Fig. 33

3. Open FRONT CONTROL PANEL to access the switch for a French Plate.

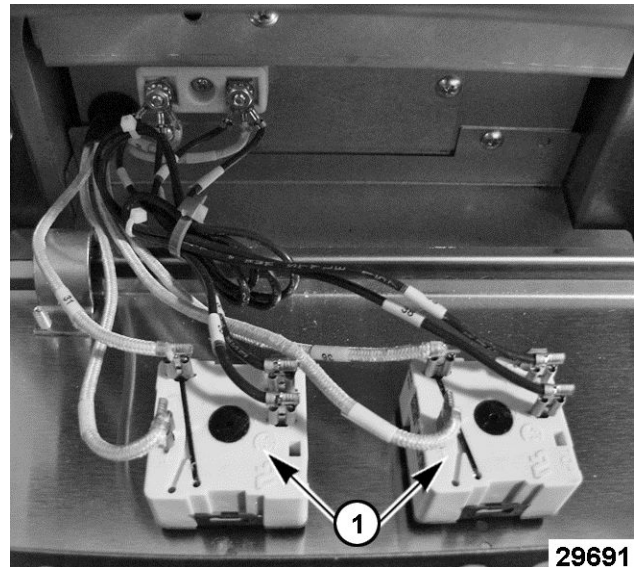

Fig. 34

**NOTE:** Infinite switches are shown.

4. If replacing switch for the top oven element, remove OVEN CONTROL PANEL.
5. Remove wire connections from switch being replaced. Note wire locations.
6. Remove switch from control panel.
7. Reverse procedure to install.
8. Check range for proper operation.

## INDICATOR LIGHTS



### **WARNING**

Disconnect the electrical power to the machine and follow lockout / tagout procedures.

1. Lower the FRONT CONTROL PANEL to access the indicator lights for griddles and Hot Tops. Remove the OVEN CONTROL PANEL for ovens.
2. Note wire locations then disconnect:
  - A. Front control panel indicator lights (1, Fig. 35) electrical connections (2, Fig. 35).
  - B. Oven control panel indicator lights (1, Fig. 36) electrical connections (2, Fig. 36).

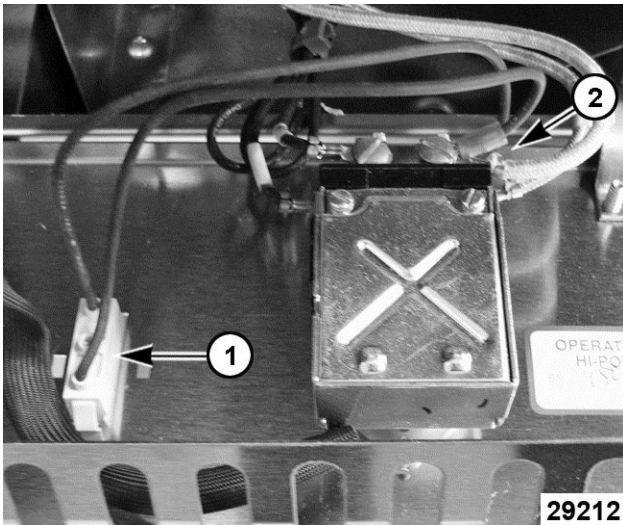

Fig. 35

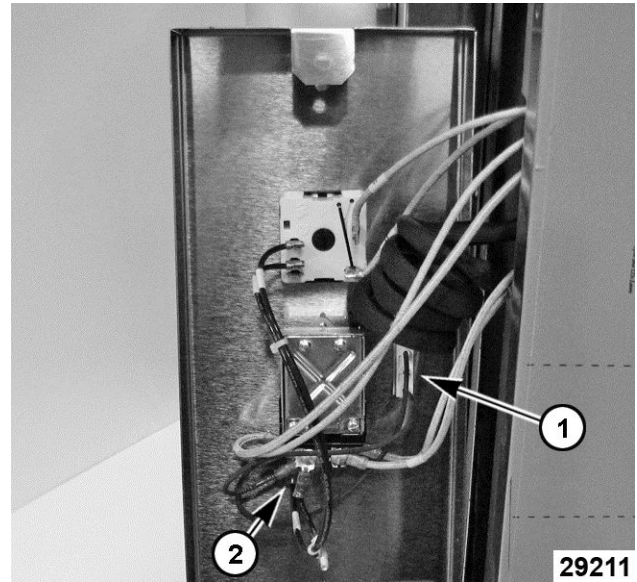

Fig. 36

3. Squeeze the tabs at both ends of the indicator light and push through the control panel.
4. Reverse procedure to install.
5. Check range for proper operation.

# ELECTRICAL OPERATION

## COMPONENT FUNCTION

- Thermostat** ..... Regulates temperature of the selected oven, griddle or Hot Top.
- 3 Heat, 4 Position Switch** ..... Controls power to the French Plates on 480V units. Provides approximately 100% of total available power per French Plate section with switch set to HI position, 50% at MED position, 25% at LO position, and 0% at the OFF position. The switch settings are: OFF, 1, 2 and 3.
- Heating Elements** ..... Provides heat for the oven and Hot Top sections.
- Infinite Switch** ..... Controls power to French Plate heaters and the top oven element for browning. Depending on switch setting, provides a range of ON time from 7% to 100%. The switch settings are: HI, MED, LO, MED-LO and VERY-LO. On 480V units, the top oven element along with the bottom oven element are both controlled by the oven thermostat.
- Indicator Lights (Red)** ..... Turns ON when power is being applied to heating elements for the oven, griddle or Hot Top.

## COMPONENT LOCATION

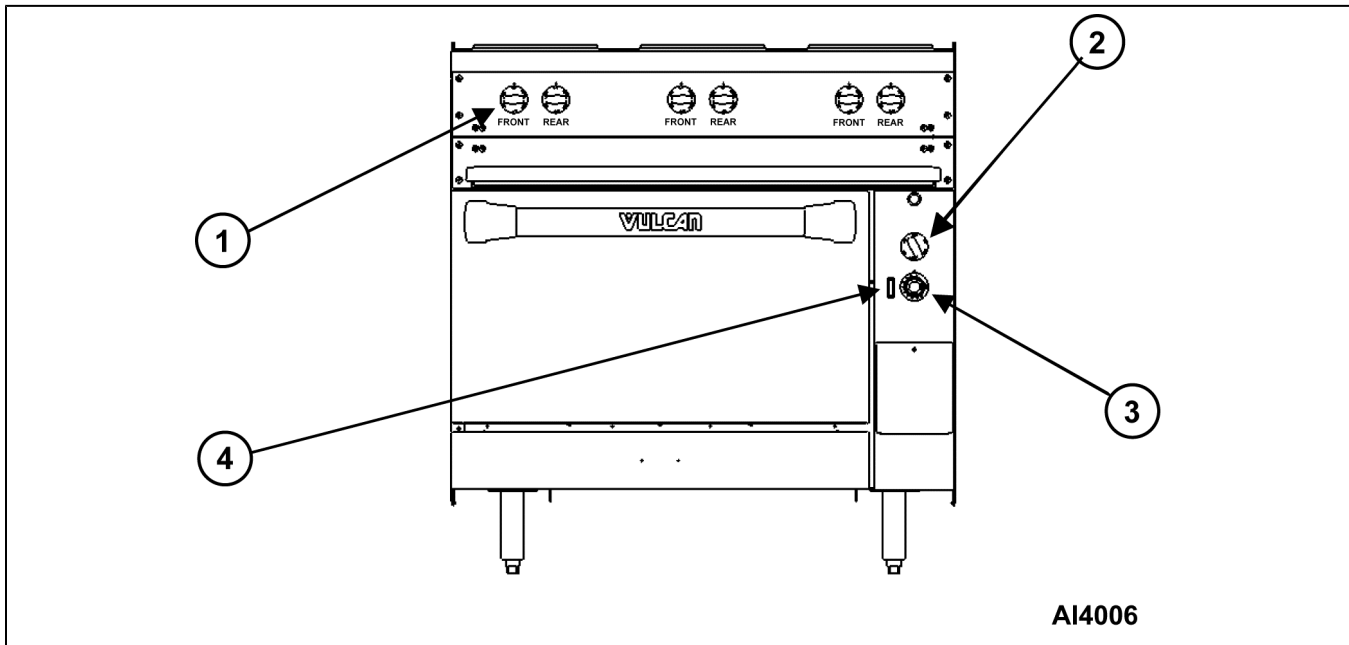

AI4006

EV36-6FP - French Plates Shown

ITEM NO.	DESCRIPTION
1	*Range top control knobs
2	Oven infinite switch knob
3	Oven thermostat knob
4	Oven indicator light

**\*Range Top Control Knobs** - Available combinations are: French Plates (FP), Hot Tops (HT) and Griddles (G). Hot Tops and Griddles have one control knob per 12" section and include an indicator light to the left of knob.

**STANDARD OVEN SEQUENCE OF OPERATION****208/240V**

1. Conditions.
  - A. Range connected to correct supply voltage.
  - B. Power at range terminal block (building circuit breakers ON).
  - C. Oven thermostat OFF (bottom element for heating).
  - D. Oven infinite switch OFF (top element for browning).
  - E. Oven at room temperature.
2. Oven infinite switch turned to desired setting.
3. Thermostat set to desired temperature.
  - A. Indicator light turns ON.
  - B. Power supplied to heating elements.
4. Oven reaches desired set temperature.
  - A. Power is removed from the heating elements and indicator light.
5. Oven temperature drops below set temperature.
  - A. Oven heating resumes and indicator light turns ON.
6. Steps 4 and 5 cycle until the thermostat is turned OFF or power is removed from the range.

**480V**

1. Conditions
  - A. Range connected to supply voltage.
  - B. Power at range terminal block (building circuit breakers ON).
  - C. Oven thermostat OFF (controls top & bottom elements for browning & heating).
  - D. Oven at room temperature.
2. Oven thermostat set to desired temperature.
  - A. Indicator light turns ON.
  - B. Power supplied to heating elements.
3. Oven reaches desired set temperature.
  - A. Power is removed from the heating elements and indicator light.
4. Oven temperature drops below set temperature.

- A. Oven heating resumes and indicator light turns ON.
5. Steps 3 and 4 cycle until the thermostat is turned OFF or power is removed from the range.



# WIRING DIAGRAMS

## EV12 RANGE TOP - 208V & 240V

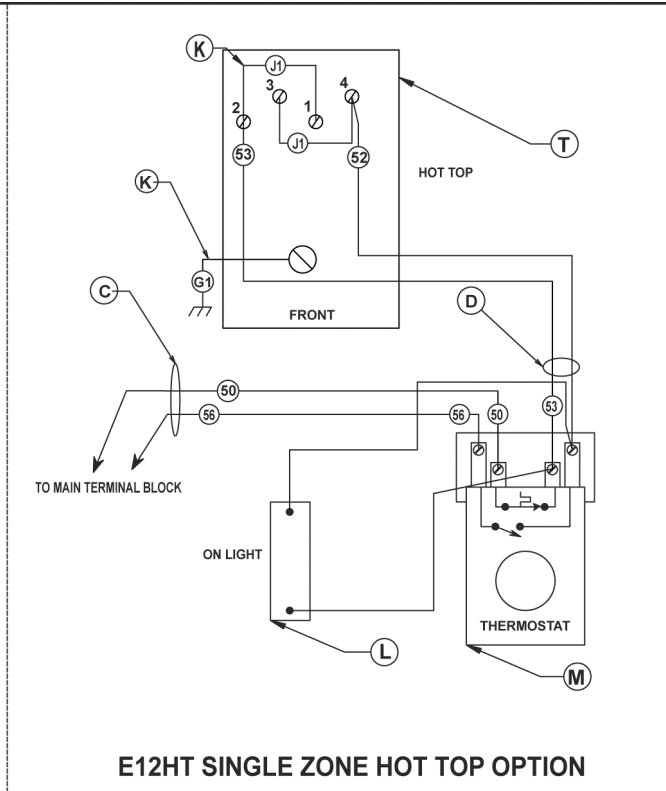
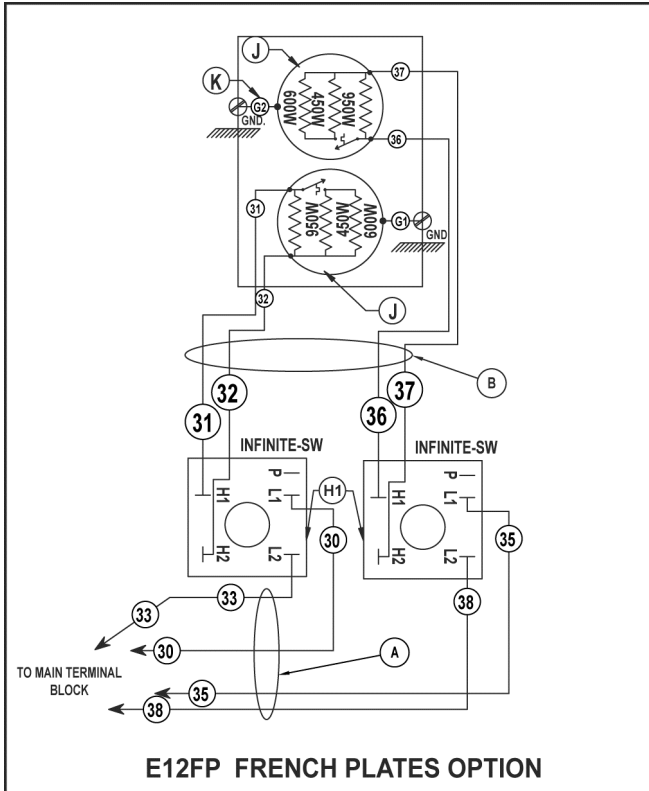

UNIT	TOTAL KW CONN.	LOAD KW PER PHASE 3-PHASE			
		L1-L2	L2-L3	L1-L3	
E12HT	5	--	--	--	
E12FP	4	2.0	2.0	--	

UNIT	NOMINAL AMPS PER LINE							
	3-PHASE		1-PH					
	208V	240V	208	240				
	X	Y	Z	X	Y	Z	X-Z	X-Z
E12HT	-	-	-	-	-	-	24	21
E12FP	9.6	17	9.6	8.3	14	8.3	19	17

UNIT	TOTAL KW CONN.	LOAD KW/PHASE			
		L1-N	L2-N		
E12HT	4.2	5	5.0	--	
E12FP	3.4	4	2.0	2.0	

UNIT	NOMINAL AMPS PER LINE				
	3-WIRE		2-WIRE		
	380Y/220	220	415Y/240	240	
	L1	L2	L1	L2	L1
E12HT	-	-	19.3	-	21
E12FP	7.8	7.8	15.6	8.5	17

REQ.	REQ.	IT.	DESCRIPTION	FIN.
-	-	R	RESISTOR 300K OHM	-
-	-	T	ELEMENT HOT TOP 5KW	-
-	1	T	ELEMENT HOT TOP 5KW	-
-	1	M	THERMOSTAT, HOT TOP	-
-	1	L	LIGHT, INDICATOR	-
-	2	K1	WIRE ASSEMBLY [J1]	-
2	1	K	WIRE ASSEMBLY [G1]	-
-	-	J	FRENCH PLATE EGO 2KW	-
2	-	J	FRENCH PLATE EGO 2KW	-
2	-	H1	SWITCH, INFINITE	-
-	-	H	SWITCH, 3 HEAT	-
-	1	D	HARNESS, GRIDDLE ELEMENT	-
-	1	C	GRIDDLE SUPPLY HARNESS	-
-	-	B1	FRENCH PLATE SUPPLY HARNESS	-
1	-	B	FRENCH PLATE SUPPLY HARNESS	-
1	-	A	FRENCH PLATE SUPPLY HARNESS	-
REQ.	REQ.	IT.	DESCRIPTION	FIN.
E12FP 208 240 VOLT	E12HT 208 240 VOLT		<b>EV12 - 208V, 240V TOP CONFIGURATION RANGE</b>	
				<b>AI4007</b>

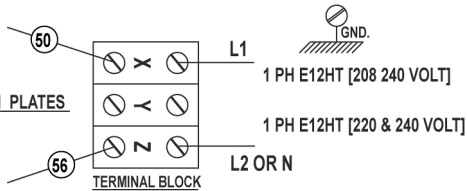
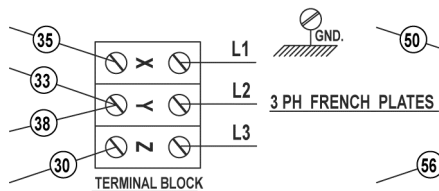
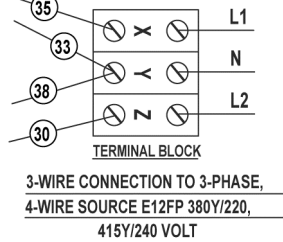
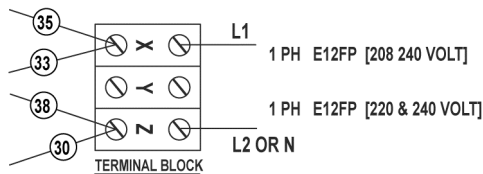

DERIVED FROM: 00-927439 REV C-01

**EV12 RANGE TOP - 480V**

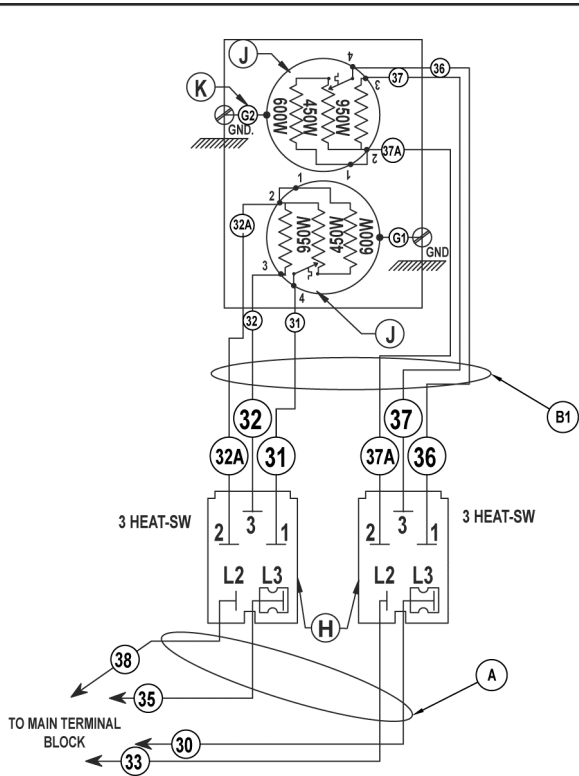

**E12FP FRENCH PLATES OPTION 480V**

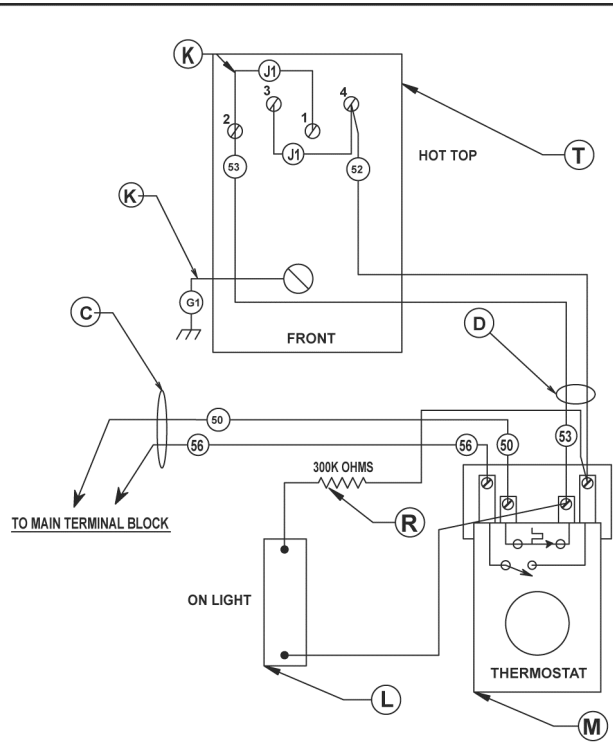

**E12HT SINGLE ZONE HOT TOP OPTION 480V**

UNIT	TOTAL KW CONN.	LOAD KW PER PHASE 3-PHASE		
		X-Y	Y-Z	Z-X
E12HT	5	--	--	--
E12FP	4	2.0	2.0	--
NOMINAL AMPS PER LINE				
3-PHASE 480V				
	X	Y	Z	1-PH 480 X-Z
E12HT	-	-	-	10.4
E12FP	4.2	7.2	4.2	8.3

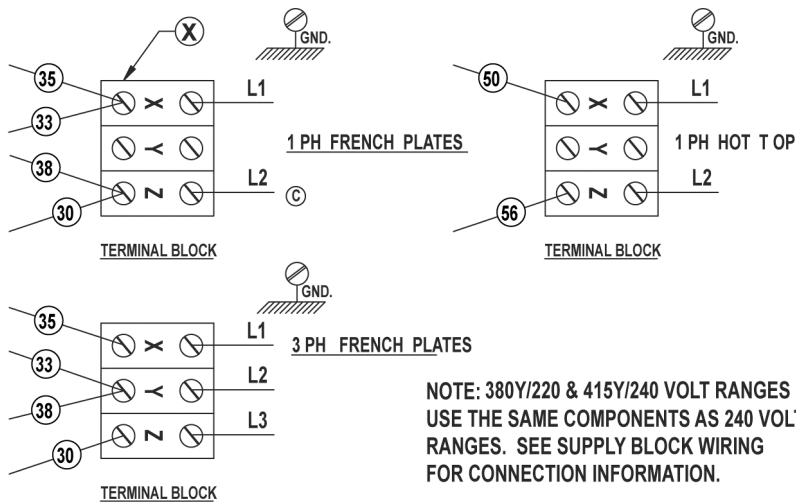

NOTE: 380Y/220 & 415Y/240 VOLT RANGES USE THE SAME COMPONENTS AS 240 VOLT RANGES. SEE SUPPLY BLOCK WIRING FOR CONNECTION INFORMATION.

DERIVED FROM: 00-927439 REV C-01

REQ	REQ	IT.	DESCRIPTION	FIN.
-	1	R	RESISTOR 300K OHM	-
-	1	T	ELEMENT HOTTOP 5KW 480 VOLT	-
-	1	M	THERMOSTAT, HOT TOP	-
-	1	L	LIGHT, INDICATOR	-
-	2	K1	WIRE ASSEMBLY [J1]	-
2	1	K	WIRE ASSEMBLY [G1]	-
2	-	J	FRENCH PLATE EGO 2KW 480 VOLT	-
-	-	H1	SWITCH, INFINATE	-
2	-	H	SWITCH, 3 HEAT	-
-	1	D	HARNES, GRIDDLE ELEMENT	-
-	1	C	GRIDDLE SUPPLY HARNES	-
1	-	B1	FRENCH PLATE SUPPLY HARNES	-
-	-	B	FRENCH PLATE SUPPLY HARNES	-
1	-	A	FRENCH PLATE SUPPLY HARNES	-
REQ	REQ	IT.	DESCRIPTION	FIN.
E12FP 480 VOLT	E12HT 480 VOLT		<b>EV12 - 480V TOP CONFIGURATION RANGE</b>	<b>AI4008</b>

**EV24 RANGE TOPS - 208V & 240V**

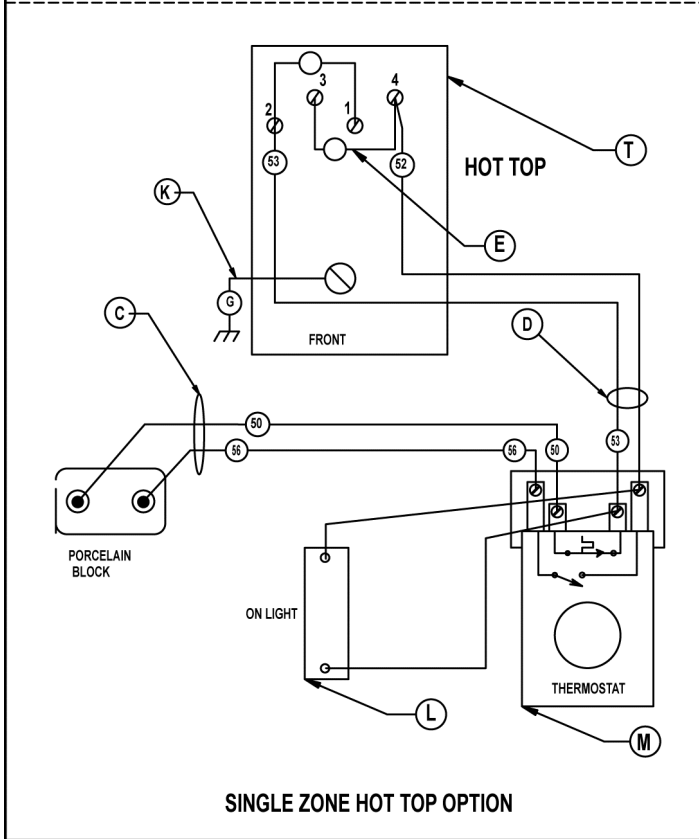
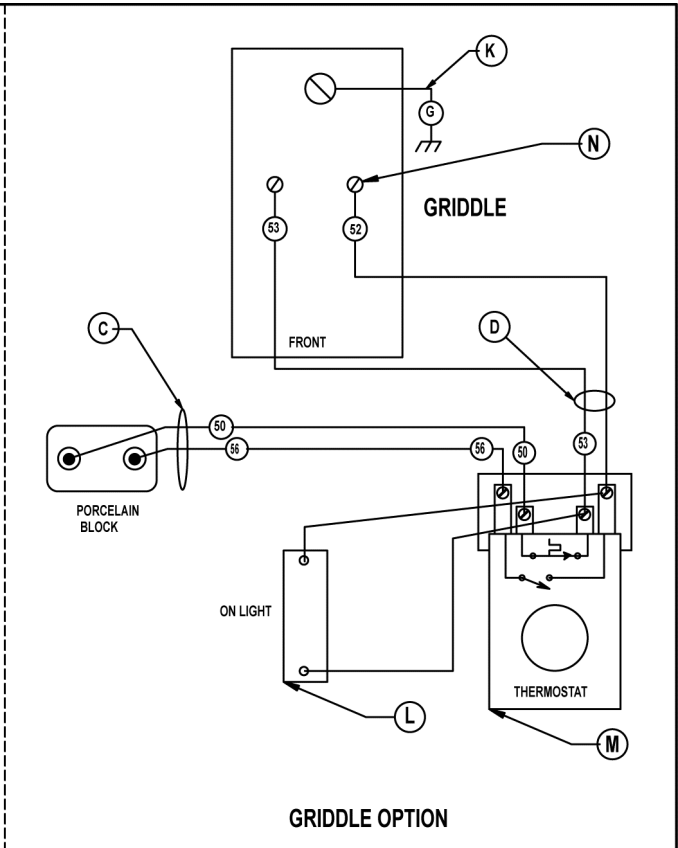
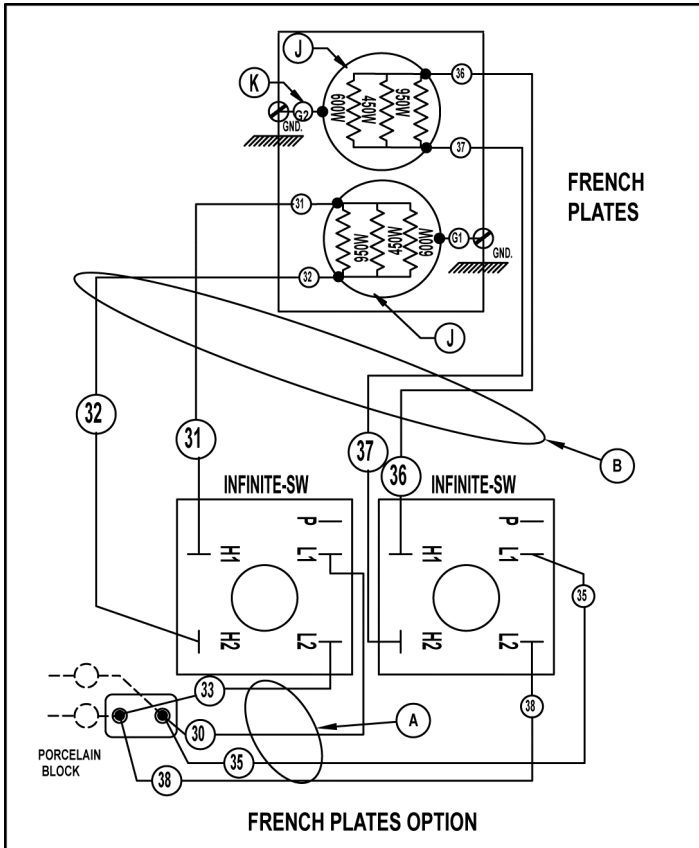

REQ HOT TOP	REQ GRD	REQ FRP	RANGE TOP CONFIGURATIONS	
1	-	-	N	ELEMENT, GRIDDLE 208 VOLT 240 VOLT
1	1	-	M	THERMOSTAT, GRIDDLE & HOT TOP
1	1	-	L	LIGHT, INDICATOR
1	1	2	K	WIRE ASSEMBLY [G]
-	-	2	J	FRENCH PLATE 2.0KW 208 VOLT 240 VOLT
-	-	2	H	SWITCH, INFINITE
-	2	-	E	WIRE ASSEMBLY [J1]
1	1	-	D	HARNES, GRIDDLE ELEMENT
1	1	-	C	HARNES, GRIDDLE
-	-	1	B	FRENCH PLATE HARNES
-	-	1	A	FRENCH PLATE SUPPLY HARNES

DERIVED FROM: 00-927530 REV F-1  
 EV & EH 24" RANGE TOPS  
 208, 240 VOLTS  
**AI4009**

**EV24 STANDARD OVEN - 208V & 240V**

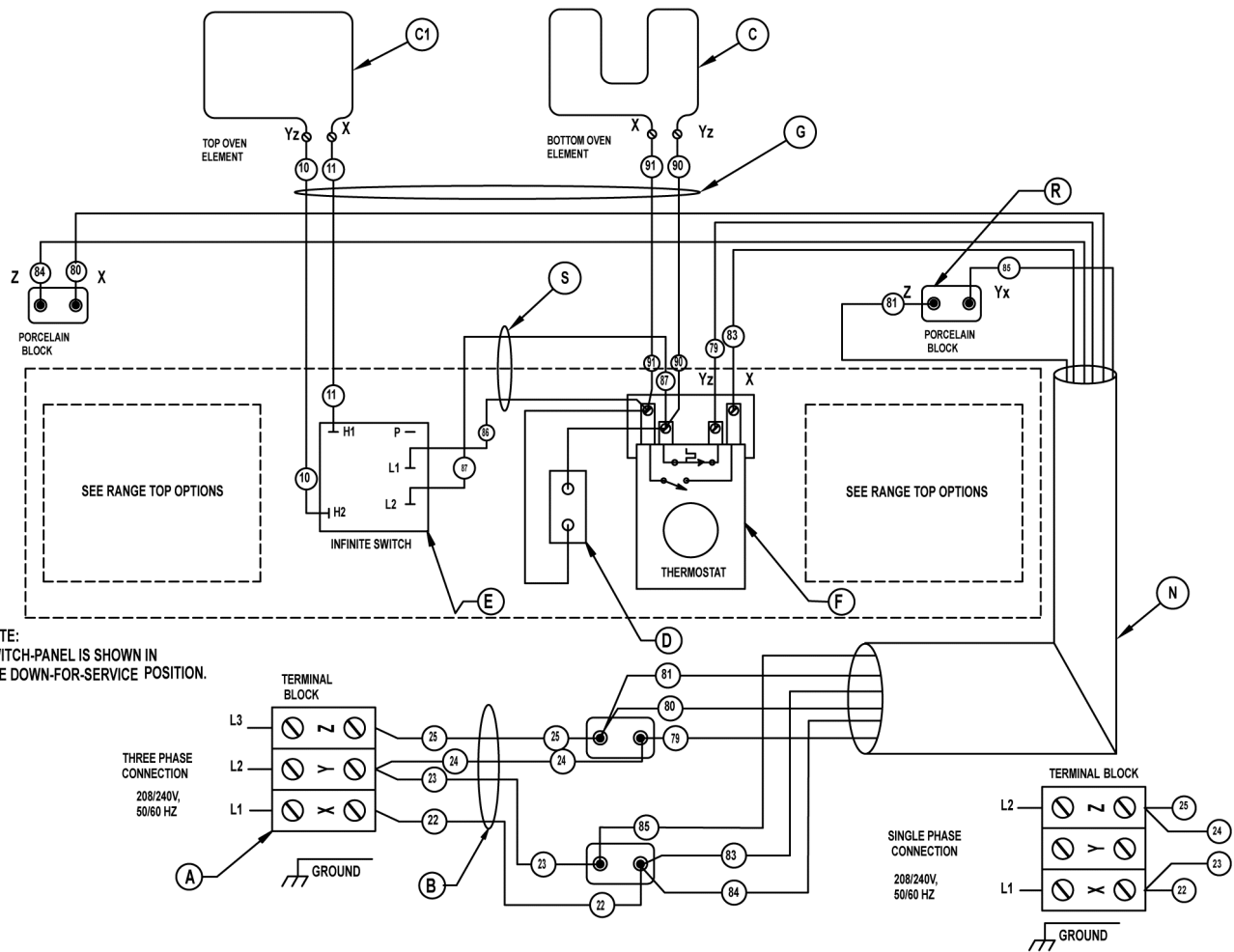

NOTE:  
SWITCH-PANEL IS SHOWN IN  
THE DOWN-FOR-SERVICE POSITION.

1	S	WIRES, TOP ELEM PWR	-
4	R	PORCELIAN BLOCK ASSEMBLY	-
1	N	HARNESS MAIN (80 RIGHT)	-
1	H	HARNESS MAIN (80 LT)	-
2	G	HARNESS OVEN ELEMENT	-
2	F	THERMOSTAT OVEN (SJ)	-
2	E	SWITCH INFINITE	-
2	D	LIGHT INDICATOR ASSEMBLY "OVEN"	-
2	C1	ELEMENT TOP 1.25KW	208 VOLT
			240 VOLT
2	C	ELEMENT BOTTOM 3.75KW	208 VOLT
			240 VOLT
1	B1	HARNESS POWER (86)	-
1	B	HARNESS POWER (24)	-
-	A1	TERMINAL BLOCK 1 POLE 220/380	-
2	A	TERMINAL BLOCK 3 POLE	-
REQ.	IT.	DESCRIPTION	FIN.

VOLTAGE BETWEEN LINES AND  
NEUTRAL MUST NOT EXCEED  
240 VAC.

380/415 V, 3PH  
50/60 Hz  
WITH NEUTRAL  
SUPPLY CONNECTION

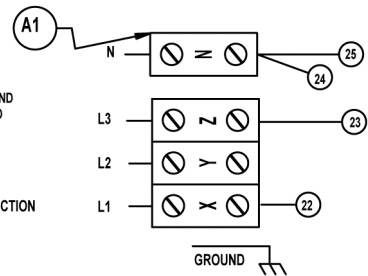

DERIVED FROM: 00-927530 REV F-1

**EV & EH 24" RANGE**  
**208, 240 VOLTS**

**AI4010**

**EV36 & EV60 RANGE TOPS - 208V & 240V**

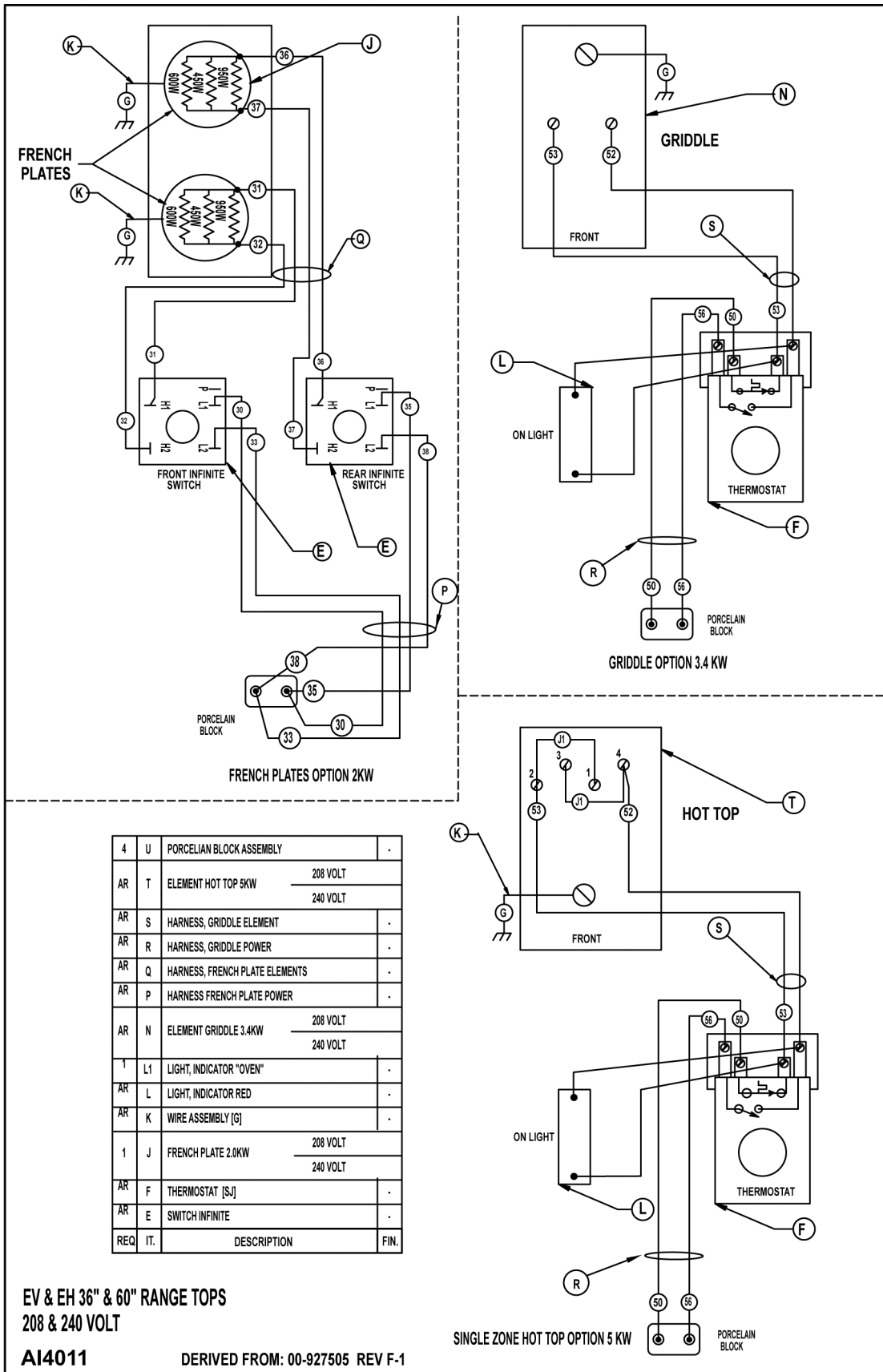

FRENCH PLATES OPTION 2KW

GRIDDLE OPTION 3.4 KW

HOT TOP

4	U	PORCELAIN BLOCK ASSEMBLY	-
AR	T	ELEMENT HOT TOP 5KW	208 VOLT 240 VOLT
AR	S	HARNES, GRIDDLE ELEMENT	-
AR	R	HARNES, GRIDDLE POWER	-
AR	Q	HARNES, FRENCH PLATE ELEMENTS	-
AR	P	HARNES FRENCH PLATE POWER	-
AR	N	ELEMENT GRIDDLE 3.4KW	208 VOLT 240 VOLT
1	L1	LIGHT, INDICATOR "OVEN"	-
AR	L	LIGHT, INDICATOR RED	-
AR	K	WIRE ASSEMBLY [G]	-
1	J	FRENCH PLATE 2.0KW	208 VOLT 240 VOLT
AR	F	THERMOSTAT [SJ]	-
AR	E	SWITCH INFINITE	-
REQ	IT.	DESCRIPTION	FIN.

EV & EH 36" & 60" RANGE TOPS  
208 & 240 VOLT

**AI4011**

DERIVED FROM: 00-927505 REV F-1

SINGLE ZONE HOT TOP OPTION 5 KW

**EV36 & EV60 STANDARD OVEN - 208V & 240V**

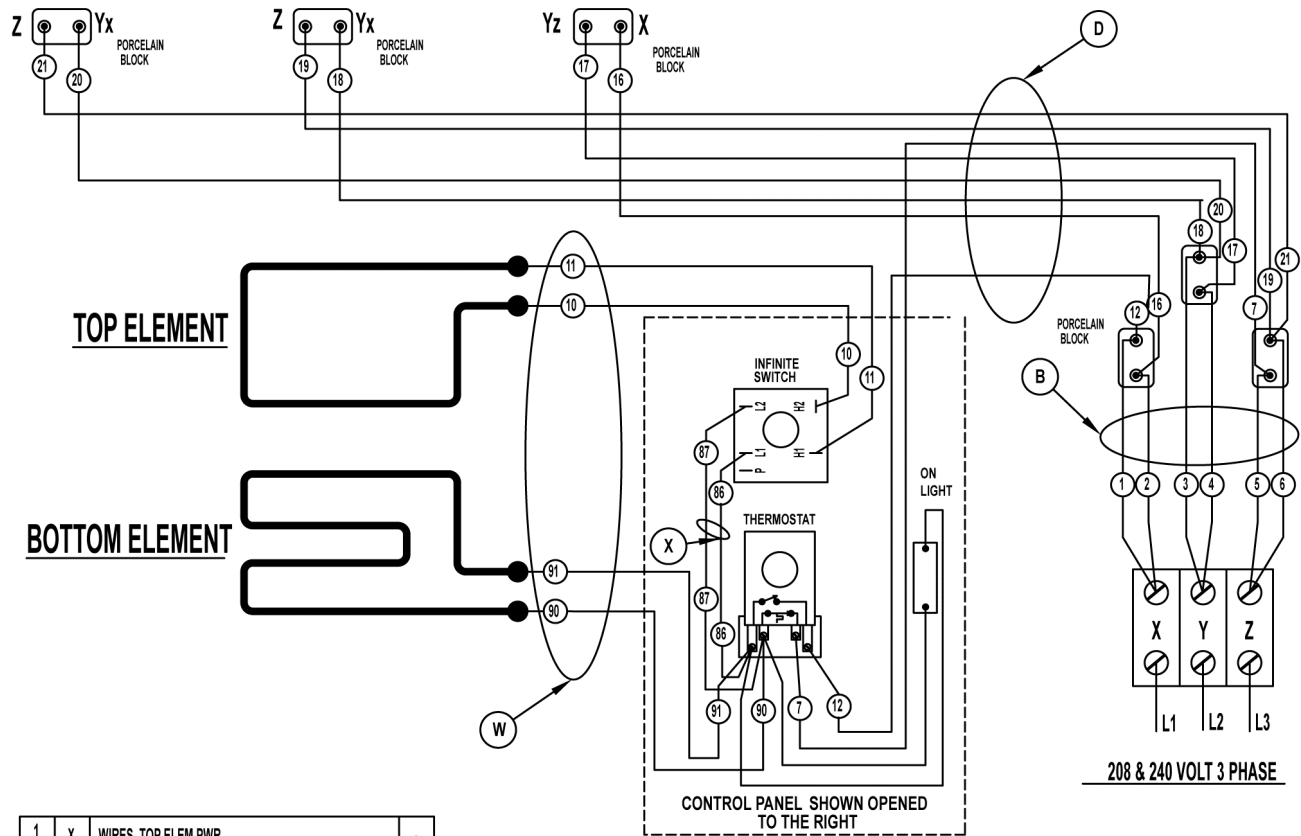

1	X	WIRES, TOP ELEM PWR	-
1	C2	ELEMENT TOP 1.75 KW	208 VOLT
			240 VOLT
1	W	HARNESS OVEN ELEMENT	-
AR	V	WIRE ASSEMBLY [J1]	-
4	U	PORCELIAN BLOCK ASSEMBLY	-
1	L1	LIGHT, INDICATOR "OVEN"	-
AR	F	THERMOSTAT [SJ]	-
AR	E	SWITCH INFINITE	-
1	D	HARNESS MAIN	-
1	C1	ELEMENT BOT 3.75 KW	208 VOLT
			240 VOLT
1	B	HARNESS POWER	-
-	A1	TERMINAL BLOCK 1 POLE 220/380	-
1	A	TERMINAL BLOCK 3 POLE	-
REQ.	IT.	DESCRIPTION	FIN.

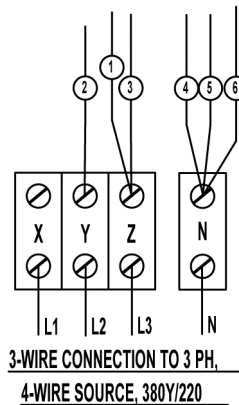
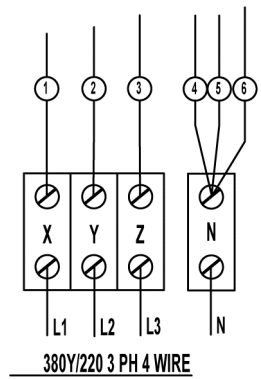
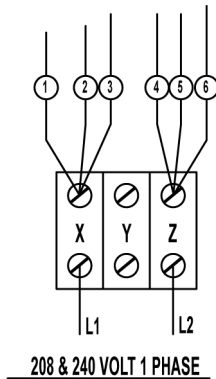

EV & EH 36" & 60" RANGES  
STANDARD OVEN  
208 & 240 VOLT

DERIVED FROM: 00-927505 REV F-1

AI4012

**EV24 RANGE TOPS - 480V**

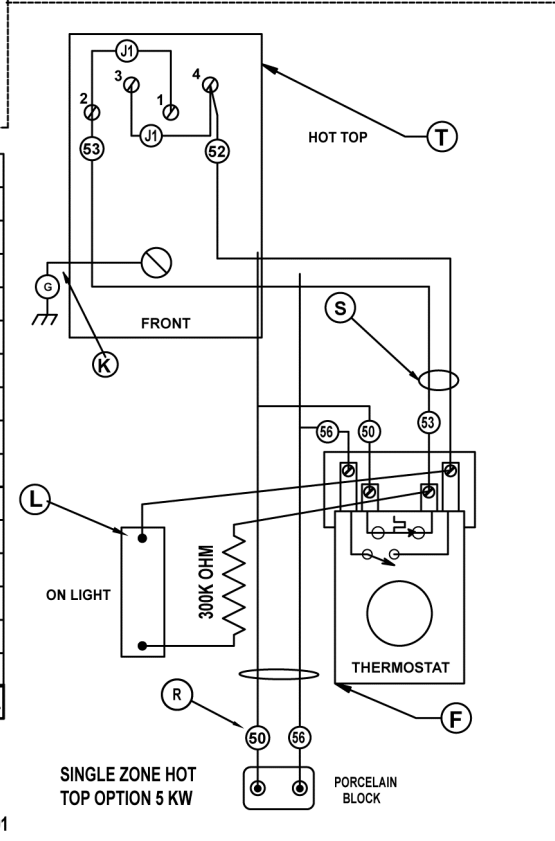
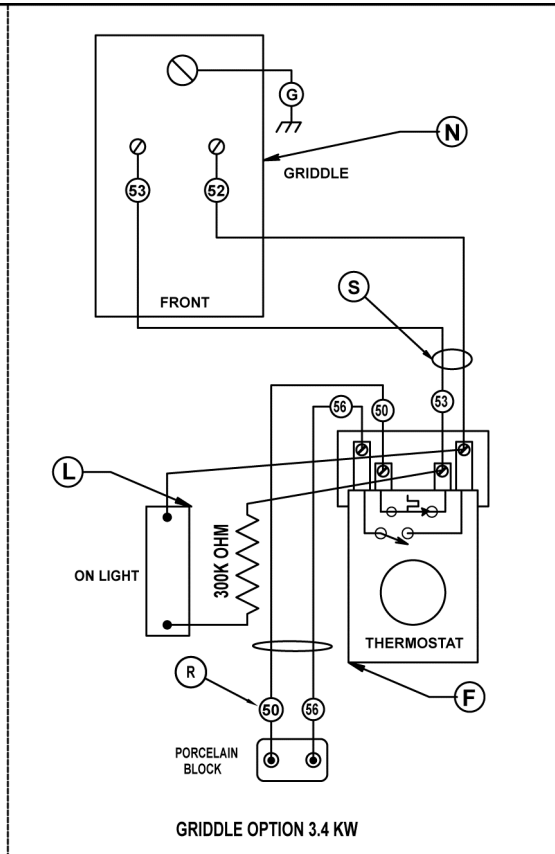
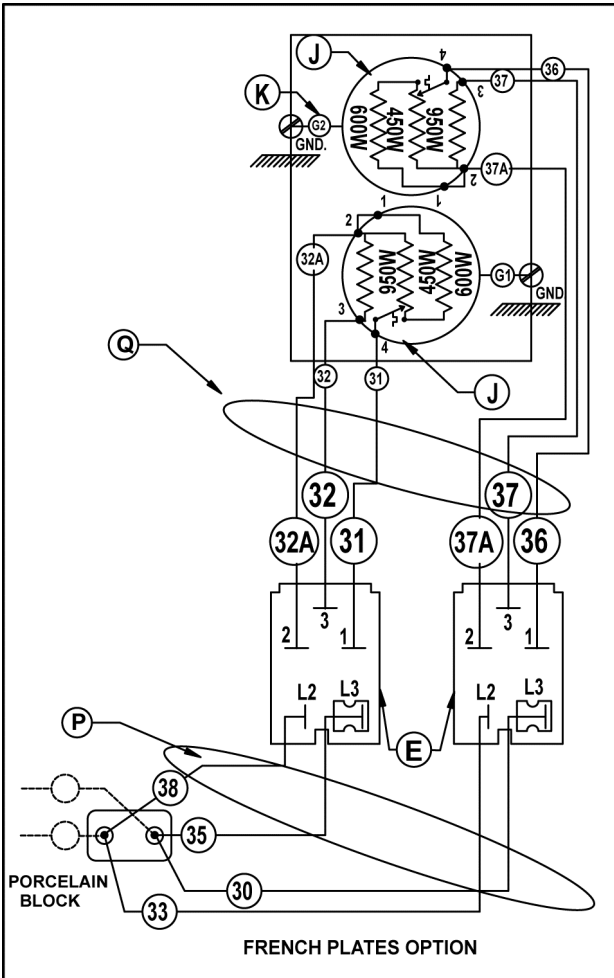

AR	V	WIRE ASSEMBLY [J1]	-
4	U	PORCELIAN BLOCK ASSEMBLY	-
AR	T	ELEMENT HOT TOP 5KW	480 VOLT
AR	S	HARNES, GRIDDLE ELEMENT	-
AR	R	HARNES, GRIDDLE POWER	-
AR	Q	HARNES, FRENCH PLATE ELEMENTS	-
AR	P	HARNES FRENCH PLATE POWER	-
AR	N	ELEMENT GRIDDLE 3.4KW	480 VOLT
AR	L	LIGHT, INDICATOR RED	-
AR	K	WIRE ASSEMBLY [G]	-
1	J	FRENCH PLATE 2.0KW	480 VOLT
AR	F	THERMOSTAT [SJ]	-
AR	E	SWITCH 3 HEAT	-
REQ. IT.		DESCRIPTION	FIN.

EV & EH 24" OF 60" RANGES  
RANGE TOPS  
480 VOLT

**AI4013**

DERIVED FROM: 00-927568 REV F-01

**EV24 STANDARD OVEN - 480V**

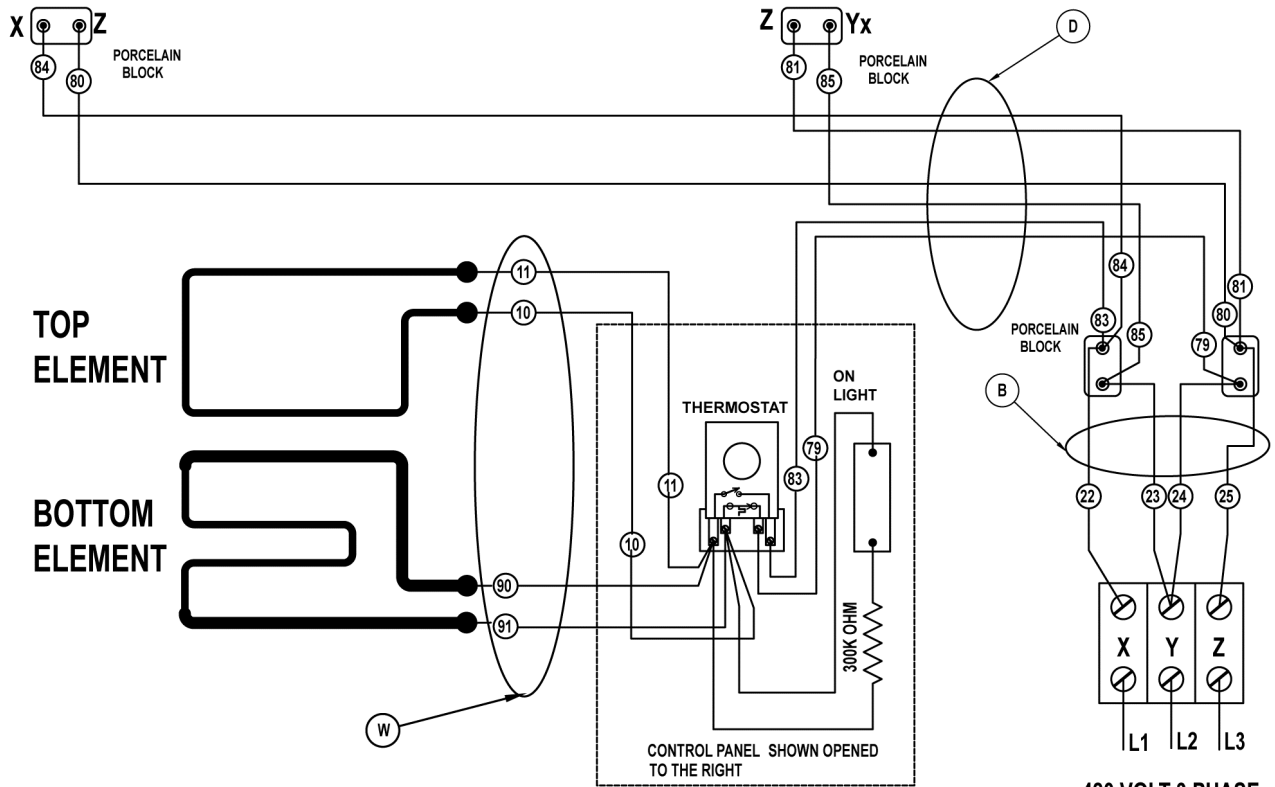

**480 VOLT 3 PHASE**

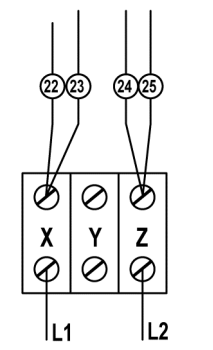

**480 VOLT 1 PHASE**

1	W	HARNES OVEN ELEMENT	-
4	U	PORCELIAN BLOCK ASSEMBLY	-
1	L1	LIGHT, INDICATOR "OVEN"	-
AR	F	THERMOSTAT [SJ]	-
AR	E	SWITCH 3 HEAT	-
1	D	HARNES MAIN [60 RIGHT]	-
1	C1	ELEMENT TOP 1.25KW 480 VOLT	
1	C	ELEMENT BOTTOM 3.75KW 480 VOLT	
1	B	HARNES POWER 24	-
-	A1	TERMINAL BLOCK 1 POLE 220/380	-
1	A	TERMINAL BLOCK 3 POLE	-
REQ	IT.	DESCRIPTION	FIN.

DERIVED FROM: 00-927568 REV F-01

**EV & EH 24" OF 60" RANGES  
STANDARD OVEN  
480 VOLT AI4014**



**EV36 RANGE TOPS - 480V**

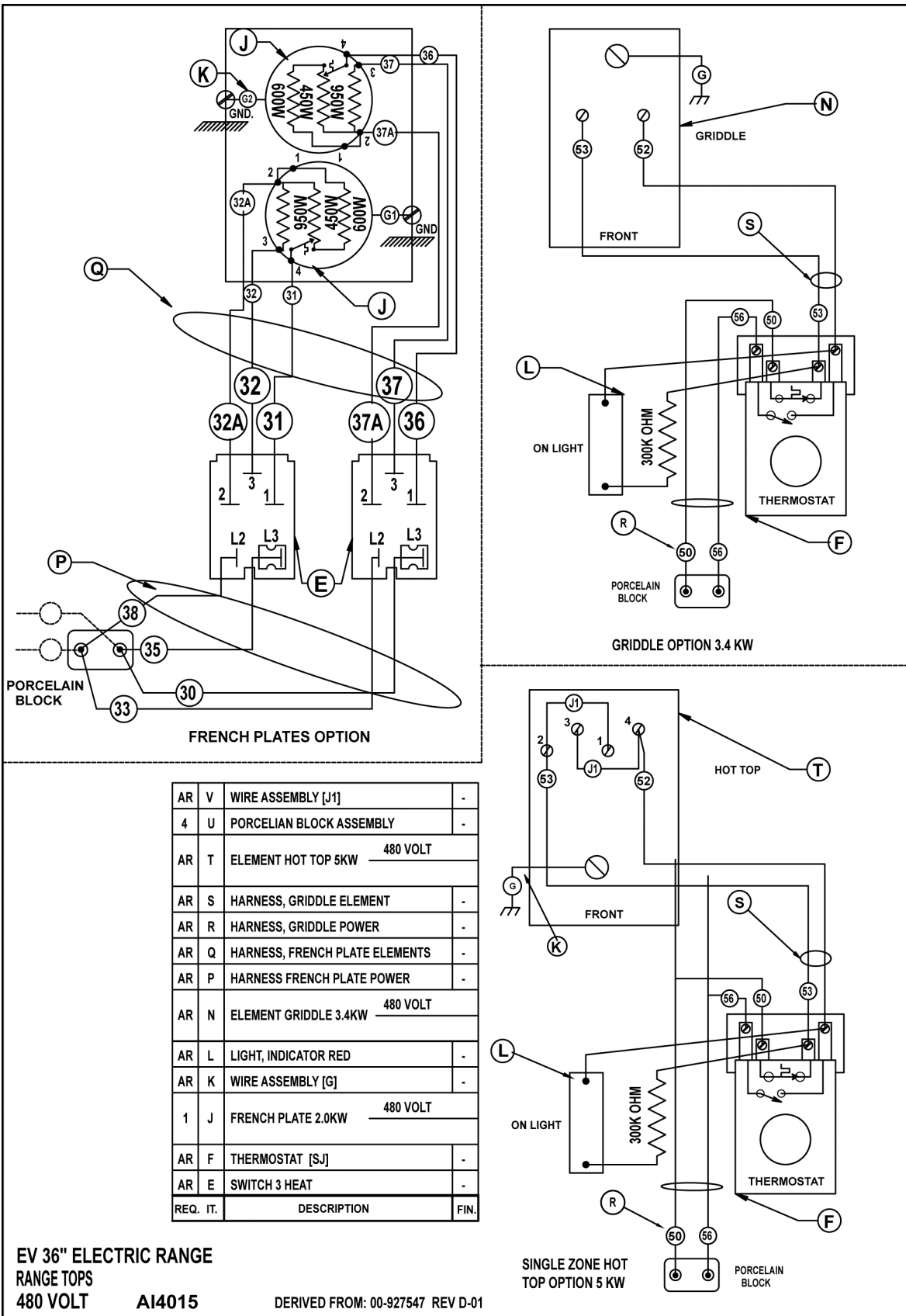

**EV36 STANDARD OVEN - 480V**

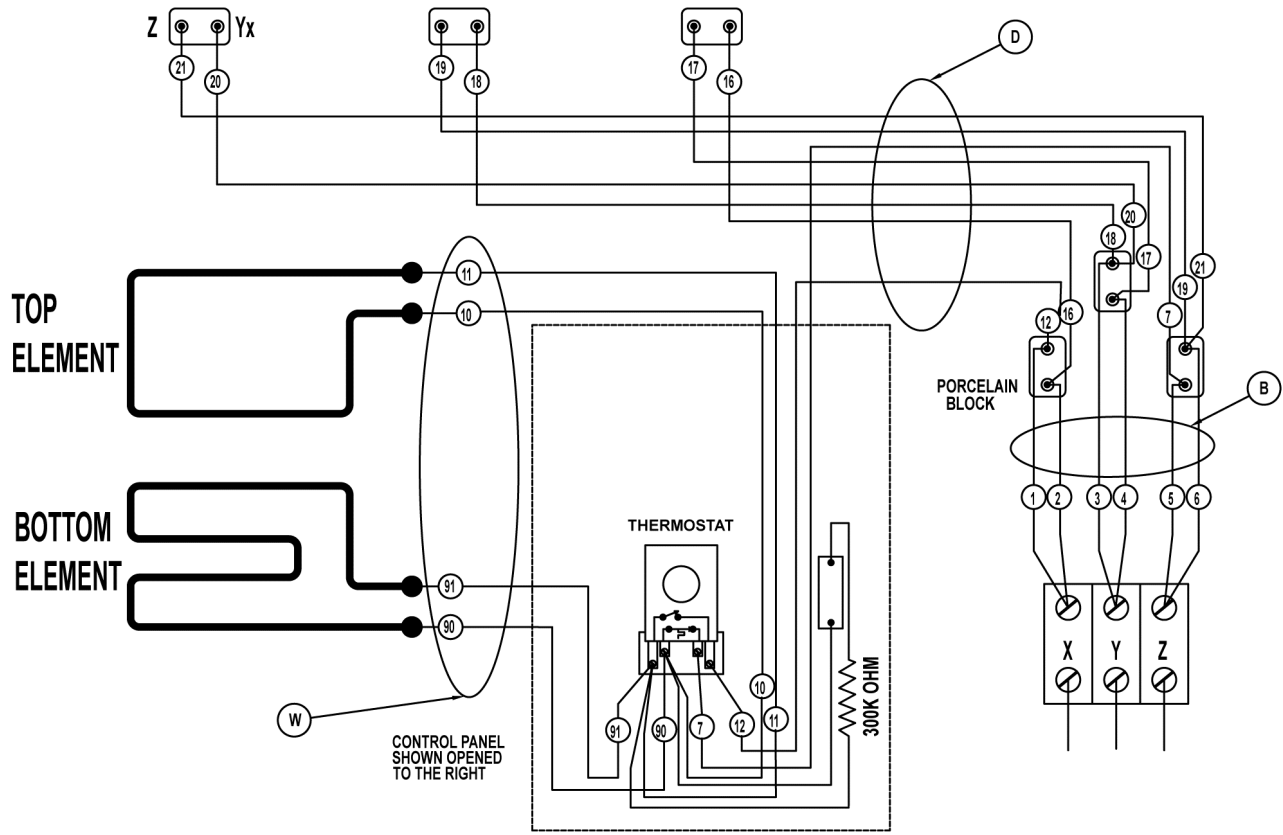

1	W	HARNESS OVEN ELEMENT	-
4	U	PORCELIAN BLOCK ASSEMBLY	-
1	L1	LIGHT, INDICATOR "OVEN"	-
AR	F	THERMOSTAT [SJ]	-
AR	E	SWITCH 3 HEAT	-
1	D	HARNESS MAIN [60 RIGHT]	-
1	C1	ELEMENT TOP 1.25KW 480 VOLT	-
1	C	ELEMENT BOTTOM 3.75KW 480 VOLT	-
1	B	HARNESS POWER 24	-
-	A1	TERMINAL BLOCK 1 POLE 220/380	-
1	A	TERMINAL BLOCK 3 POLE	-
REQ.	IT.	DESCRIPTION	FIN.

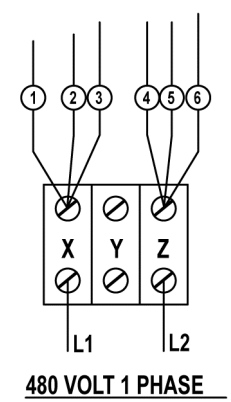

DERIVED FROM: 00-927547 REV D-01

**EV36 ELECTRIC RANGE  
STANDARD OVEN  
480V**

**AI4016**

# TROUBLESHOOTING

## TROUBLESHOOTING - STANDARD OVEN

SYMPTOM	POSSIBLE CAUSES
No heat.	<ol style="list-style-type: none"> <li>1. No power to range.</li> <li>2. Oven wiring malfunction.</li> <li>3. Thermostat malfunction.</li> <li>4. Heating elements malfunction.</li> </ol>
Heat from top oven element only.	<ol style="list-style-type: none"> <li>1. Oven thermostat malfunction.</li> <li>2. Oven wiring malfunction.</li> <li>3. Bottom heating element malfunction.</li> </ol>
Heat from bottom oven element only.	<ol style="list-style-type: none"> <li>1. Infinite switch in OFF position or malfunction.</li> <li>2. Top heating element malfunction.</li> </ol>
Cooking problems.	<ol style="list-style-type: none"> <li>1. Refer to the <u>Installation &amp; Operation Manual</u>.</li> </ol>
Oven temperature not at set point.	<ol style="list-style-type: none"> <li>1. Thermostat not calibrated. See <u>OVEN THERMOSTAT CALIBRATION</u>.</li> <li>2. Thermostat malfunction.</li> </ol>

## TROUBLESHOOTING - RANGE TOPS

**NOTE:** Range tops can be a combination of French Plates, griddle, or Hot Tops.

SYMPTOM	POSSIBLE CAUSES
Range tops do not heat.	<ol style="list-style-type: none"> <li>1. No power to range (circuit breaker open).</li> <li>2. Range wiring malfunction.</li> <li>3. Thermostat malfunction (griddle, Hot Top).</li> <li>4. Infinite switch malfunction (French Plates 208-240V)</li> <li>5. 3 heat switch malfunction (French Plates 480V).</li> <li>6. Heating element malfunction.</li> </ol>
Griddle or Hot Top thermostat not cycling at set temperature.	<ol style="list-style-type: none"> <li>1. Thermostat needs calibrated. See <u>GRIDDLE THERMOSTAT CALIBRATION</u> or <u>HOT TOP THERMOSTAT CALIBRATION</u>.</li> <li>2. Thermostat bulb positioned incorrectly.</li> <li>3. Thermostat malfunction.</li> </ol>
Cooking problems.	<ol style="list-style-type: none"> <li>1. Refer to the <u>Installation &amp; Operation Manual</u>.</li> </ol>
Griddle or Hot Top heats beyond set temperature.	<ol style="list-style-type: none"> <li>1. Thermostat not calibrated. See <u>GRIDDLE THERMOSTAT CALIBRATION</u> or <u>HOT TOP THERMOSTAT CALIBRATION</u></li> <li>2. Thermostat malfunction.</li> </ol>