

RESTAURANT RANGES

VULCAN**ENDURANCE GAS RESTAURANT RANGE**
36" CHARBROILER / 36" WIDE GAS RANGE

Model 36S-36CBN

**SPECIFICATIONS**

36" wide gas restaurant range, Vulcan Model No. 36S-36CBN. Fully MIG welded aluminized steel frame for added durability. Stainless steel front, sides, backriser and 6" adjustable legs. Extra deep crumb tray with welded corners. 36" charbroiler with six 16,000 BTU/hr. burners with supercharger dividers. Total 96,000 BTU/hr. Burner knobs are cool to the touch, high temperature material. One oven: 35,000 BTU/hr. standard bakers depth ovens with porcelain oven bottom and door panel, measures 27"d x 26³/₈"w x 14"h. Oven thermostat adjusts from 250°F to 500°F with a low setting. Oven is supplied with two racks, two rack guide sets, and four rack positions. Oven door is heavy duty with an integrated door hinge/spring mechanism requiring no adjustment. 3/4" rear gas connection and pressure regulator. Total input 131,000 BTU/hr.

Exterior Dimensions:

34"d x 36"w x 58"h on 6" adjustable legs

- 36S-36CBN** 1 Standard Oven / Natural Gas
- 36S-36CBP** 1 Standard Oven / Propane
- 36C-36CBN** 1 Convection Oven / Natural Gas
- 36C-36CBP** 1 Convection Oven / Propane

STANDARD FEATURES

- Fully MIG welded frame
- Stainless steel front, sides, backriser
- 6" stainless steel adjustable legs
- 36" charbroiler with six 16,000 BTU/hr. burners with supercharger dividers. Total 96,000 BTU/hr.
- Extra deep pull out stainless steel crumb trays with welded corners
- 35,000 BTU/hr. baker's depth standard oven cavity. Full size sheet pans fit side-to-side or front-to-back.
- Oven thermostat adjusts from 250°F to 500°F
- Two oven racks and four rack positions
- 32,000 BTU/hr. convection oven in place of standard oven, 24"d x 26³/₈"w x 13⁷/₈"h (115v - 1 phase blower motor 4 amp, 6' cord and plug), includes three oven racks. Full size sheet pans only fit side-to-side in convection oven. Convection oven motor requires field attachment.
- One year limited parts and labor warranty

ACCESSORIES (Packaged & Sold Separately)

- Extra oven rack with rack guides
- Casters (set of four)
- Leveling casters (set of four)
- Flanged feet (set of four)
- 10" stainless steel stub back
- Towel bar
- Condiment rail
- Fryer shield

VULCAN

a division of ITW Food Equipment Group LLC

P.O. Box 696 ■ Louisville, KY 40201 ■ Toll-free: 1-800-814-2028 ■ Local: 502-778-2791 ■ Quote & Order Fax: 1-800-444-0602



ENDURANCE GAS RESTAURANT RANGE

36" CHARBROILER / 36" WIDE GAS RANGE

INSTALLATION INSTRUCTIONS

1. A pressure regulator sized for this unit is included. Natural gas 5.0" W.C., propane gas 10.0" W.C.
2. Gas line connecting to range must be 3/4" or larger. If flexible connectors are used, the inside diameter must be 3/4" or larger.
3. An adequate ventilation system is required for commercial cooking equipment. Information may be obtained by writing to the National Fire Protection Association, 1 Batterymarch Park, Quincy, MA 02269, www.NFPA.org. When writing, refer to NFPA No. 96.
4. These units are manufactured for installation in accordance with ANSZ223.1A (latest edition), National Fuel Gas Code. Copies may be obtained from The American Gas Association, 400 N Capitol St. NW, Washington, DC 20001, www.AGA.org.

5. **Clearances**

	Rear	Sides
Combustible	6"	10"
Standard Oven Non-combustible	0"	0"
Convection Oven Non-combustible	Min. 4"	0"
6. For proper combustion, install equipment on adjustable legs or casters provided with unit.

NOTE: In line with its policy to continually improve its product, Vulcan reserves the right to change materials and specifications without notice.

**Specify type of gas when ordering.
Specify altitude when above 2,000 feet.**

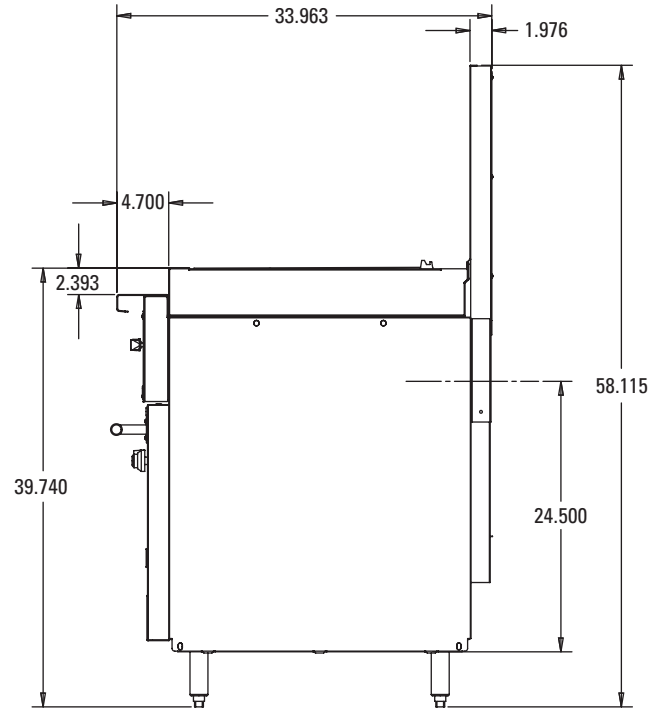
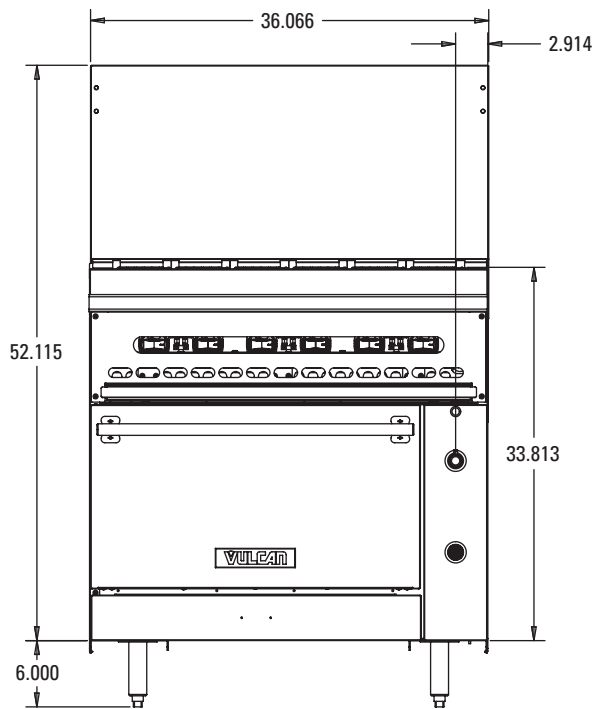

TOP CONFIGURATION	MODEL NUMBER	DESCRIPTION	TOTAL INPUT BTU / HR	SHIPPING WEIGHT LBS / KG
	36S-36CBN	1 Standard Oven / 35" Charbroiler / Natural Gas	131,000	564 / 256
	36S-36CBP	1 Standard Oven / 35" Charbroiler / Propane	128,000	564 / 256
	36C-36CBN	1 Convection Oven / 35" Charbroiler / Natural Gas	128,000	624 / 283
	36C-36CBP	1 Convection Oven / 35" Charbroiler / Propane	128,000	624 / 283

This appliance is manufactured for commercial use only and is not intended for home use.



a division of ITW Food Equipment Group LLC

P.O. Box 696 ■ Louisville, KY 40201 ■ Toll-free: 1-800-814-2028 ■ Local: 502-778-2791 ■ Quote & Order Fax: 1-800-444-0602

NOTE: In line with its policy to continually improve its products, Vulcan reserves the right to change materials and specifications without notice.